

Misyonumuz

İnsanların hayatlarını kolaylaştıracak yenilikçi, emniyetli, güvenilir ve konforlu dikey taşıma çözümleri sunmak.

Our Mission

To provide innovative, safety, reliable and comfortable vertical transportation solutions that will make people's lives easier.

Misyonumuz

Teknolojiye ve insana yatırım yapan, müşterilerine kaliteli ve sürdürülebilir ürün ve hizmet sunan Pazar lideri bir firma olmak.

Our Vision

To be a market-leading company that invests in technology and people, offers quality and sustainable products and services to the customers.

Değerlerimiz

- Güvenilirlik ve dürüstlük tartışılmaz ilkelerimizdir.
- En önemli sermayemiz insan kaynağımızdır.
- Ekip olarak çalışırız.
- Müşteri Odaklıyız.
- Tüm paydaşlarımızla işbirliğine dayalı samimi ilişkiler kurarız.
- Faaliyet gösterdiğimiz ülkelerde yasalara uyumlu hareket ederiz.
- Farklılıklardan doğan zenginliğin gücüne inanırız.
- Her çalışanımızın kendini rahat ve güvenli hissedeceği çalışma ortamı sağlarız.
- Sorumluluklarımızın bilincindeyiz.
- Çevreye ve topluma saygı gösteririz.

Our Principles

- Reliability and honesty are our indisputable principles.
- Our most important capital is human resources.
- We work as a team.
- We are customer-oriented.
- We establish sincere relations based on cooperation with all our working partners.
- We act in accordance with the laws in the countries where we operate.
- We believe in the power of wealth arising from differences.
- We provide a working environment in which every employee will feel comfortable and safe.
- We are aware of our responsibilities.
- We respect the environment and society.



Hakkımızda

2015 yılında Iğdır Organize Sanayi Bölgesinde 3000m2'si kapalı olmak üzere toplam 10.000 m2'lik alanda kurulan firmamız, Doğu Anadolu bölgesinde paket asansör ve ekipmanları üretimi yapan tek imalat fabrikasıdır. Şirketimiz asansör imalatı konusunda uzun yıllar tecrübe kazanmış şirketlerden gerekli alt yapı desteğini almıştır. Firmamız Türkiye ve dünya daki asansör üretim standartlarına göre üretim yapmaktadır. Ürünlerimiz bilgisayar ortamında CAD programları aracılığıyla tasarlanıp kusursuz olarak üretilmektedir. Ürün yelpazemizde insan asansörleri, yük asansörleri, sedye asansörleri, servis asansörleri üretim ve asansör malzemeleri satışı bulunmaktadır. Avelice Asansör, Iğdır ilinin stratejik konumundan dolayı Azerbaycan, İran, Gürcistan ve Nahçıvan'a ihracat yaparak hizmet yelpazesini genişletmiştir. Avelice Asansör nitelikli insan kaynağı, güçlü alt yapı ve çözüm odaklı yaklaşımı ile satışının her aşamasında ve sonrasında müşterilerinin her zaman yanındadır.

About Us

Our company, which was established in 2015 in Iğdır Organized Industrial Zone on a total area of 10,000 m2, 3000 m2 of which is closed, is the only manufacturing factory in the Eastern Anatolia region in Turkey that produces package elevators and equipment. Our company has received the necessary infrastructure support from companies that have gained experience in elevator manufacturing for many years. Our company is engaged in manufacturing according to lift production standards in Turkey and the world. Our products are designed and produced perfectly in computer environment using CAD programs. Our products includes human elevators, freight elevators, hospital elevators, service elevators production and elevator materials sales. Avelice Elevator has expanded its service range by exporting to Azerbaijan, Iran, Georgia and Nakhichevan due to the strategic location of the province of Iğdır. With its qualified human resources, strong infrastructure and solution-oriented approach, Avelice Elevator is always with its customers at every stage of and after sales.



2010 Series

DETAYLAR

Kaplama	: Laminat
Aksesuar	: Paslanmaz
Tavan	: Lazer Kesim
Zemin	: PVC
Ayna	: Tam Boy

DETAIL

Covering	: Laminate
Accessory	: Stainless Steel
Ceiling	: Laser Cutting
Floor	: PVC
Mirror	: Full Size

ДЕТАЛИ

Покрытие	: Ламинат
Аksesуар	: Нержавеющая сталь
Потолок	: Лазерная резка
Пол	: ПВХ
Зеркало	: Полный размер

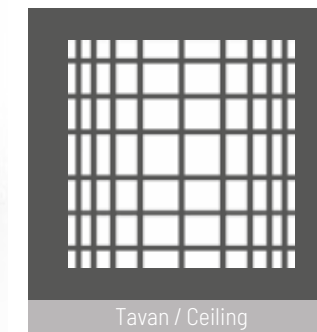



2020 Series

DETAYLAR

Kaplama	: Laminat
Aksesuar	: Paslanmaz
Tavan	: Lazer Kesim
Zemin	: Granit
Ayna	: Tam Boy

DETAIL

Covering	: Laminate
Accessory	: Stainless Steel
Ceiling	: Laser Cutting
Floor	: Granite
Mirror	: Full Size

ДЕТАЛИ

Покрытие	: Ламинат
Аksesуар	: Нержавеющая сталь
Потолок	: Лазерная резка
Пол	: Гранит
Зеркало	: Полный размер

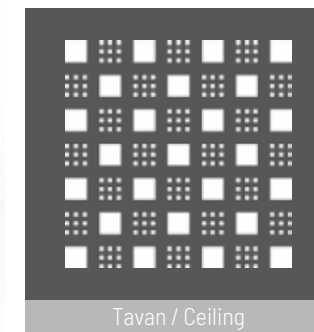



2030 Series

DETAYLAR

Kaplama	: Laminat
Aksesuar	: Paslanmaz
Tavan	: Lazer Kesim
Zemin	: Granit
Ayna	: Tam Boy

DETAIL

Covering	: Laminate
Accessory	: Stainless Steel
Ceiling	: Laser Cutting
Floor	: Granite
Mirror	: Full Size

ДЕТАЛИ

Покрытие	: Ламинат
Аксессуар	: Нержавеющая сталь
Потолок	: Лазерная резка
Пол	: Гранит
Зеркало	: Полный размер

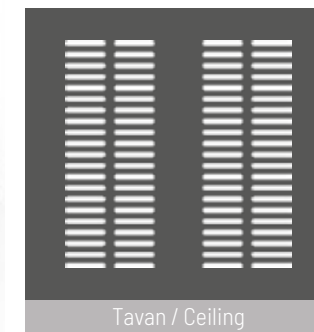



2040 Series

DETAYLAR

Kaplama	: Laminat
Aksesuar	: Paslanmaz
Tavan	: Lazer Kesim
Zemin	: PVC
Ayna	: Tam Boy

DETAIL

Covering	: Laminate
Accessory	: Stainless Steel
Ceiling	: Laser Cutting
Floor	: PVC
Mirror	: Full Size

ДЕТАЛИ

Покрытие	: Ламинат
Аksesуар	: Нержавеющая сталь
Потолок	: Лазерная резка
Пол	: ПВХ
Зеркало	: Полный размер

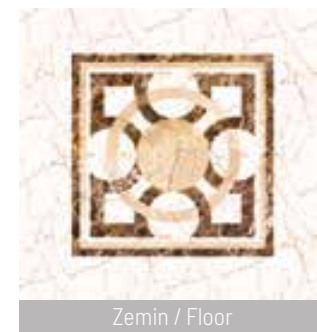
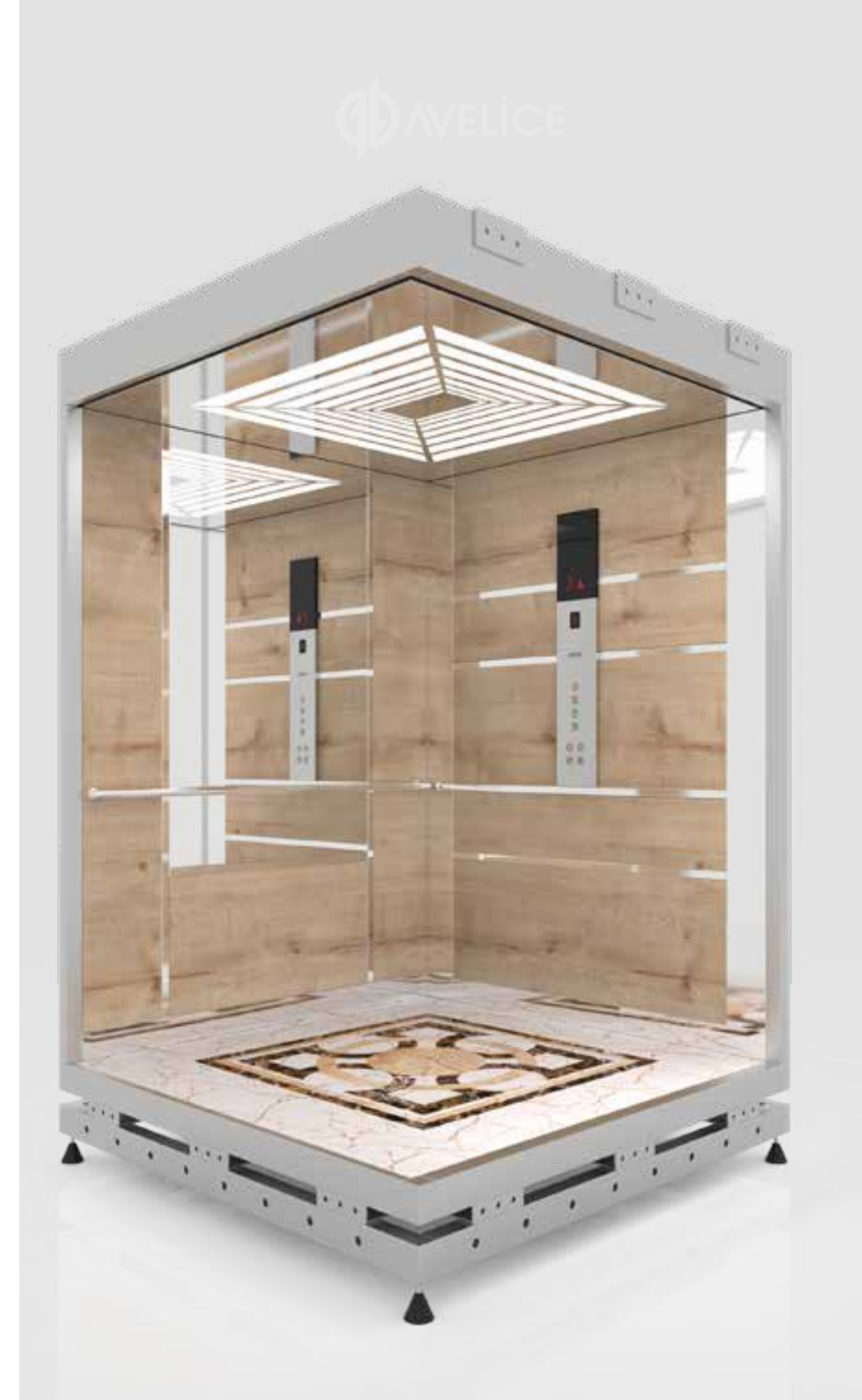



2050 Series

DETAYLAR

Kaplama	: Laminat
Aksesuar	: Paslanmaz
Tavan	: Lazer Kesim
Zemin	: Granit
Ayna	: Tam Boy

DETAIL

Covering	: Laminate
Accessory	: Stainless Steel
Ceiling	: Laser Cutting
Floor	: Granite
Mirror	: Full Size

ДЕТАЛИ

Покрытие	: Ламинат
Аксессуар	: Нержавеющая сталь
Потолок	: Лазерная резка
Пол	: Гранит
Зеркало	: Полный размер

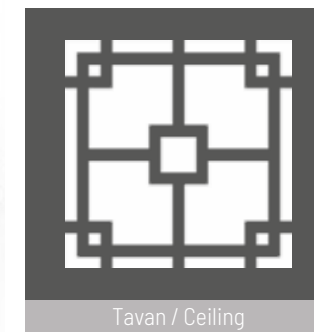
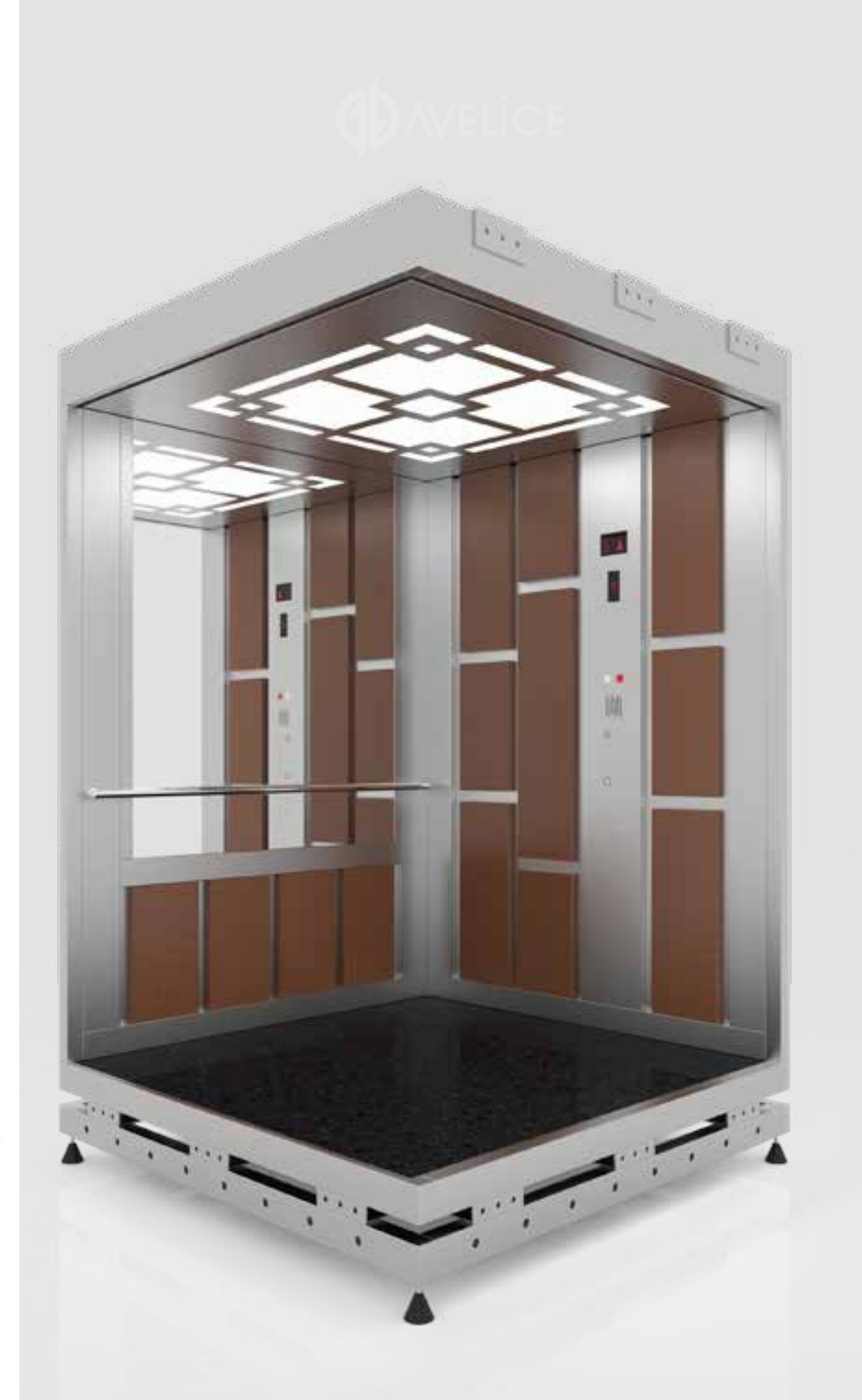



2060 Series

DETAYLAR

Kaplama	: Laminat + Paslanmaz
Aksesuar	: Paslanmaz
Tavan	: Lazer Kesim
Zemin	: Granit
Ayna	: Tam Boy

DETAIL

Covering	: Laminate + Stainless Steel
Accessory	: Stainless Steel
Ceiling	: Laser Cutting
Floor	: Granite
Mirror	: Full Size

ДЕТАЛИ

Покрытие	: ламинат + нержавеющая сталь
Аksesуар	: Нержавеющая сталь
Потолок	: Лазерная резка
Пол	: Гранит
Зеркало	: Полный размер

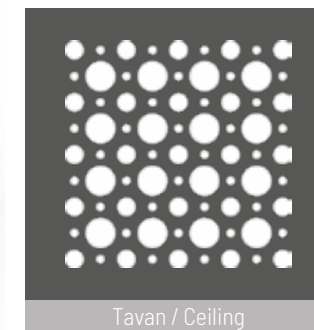
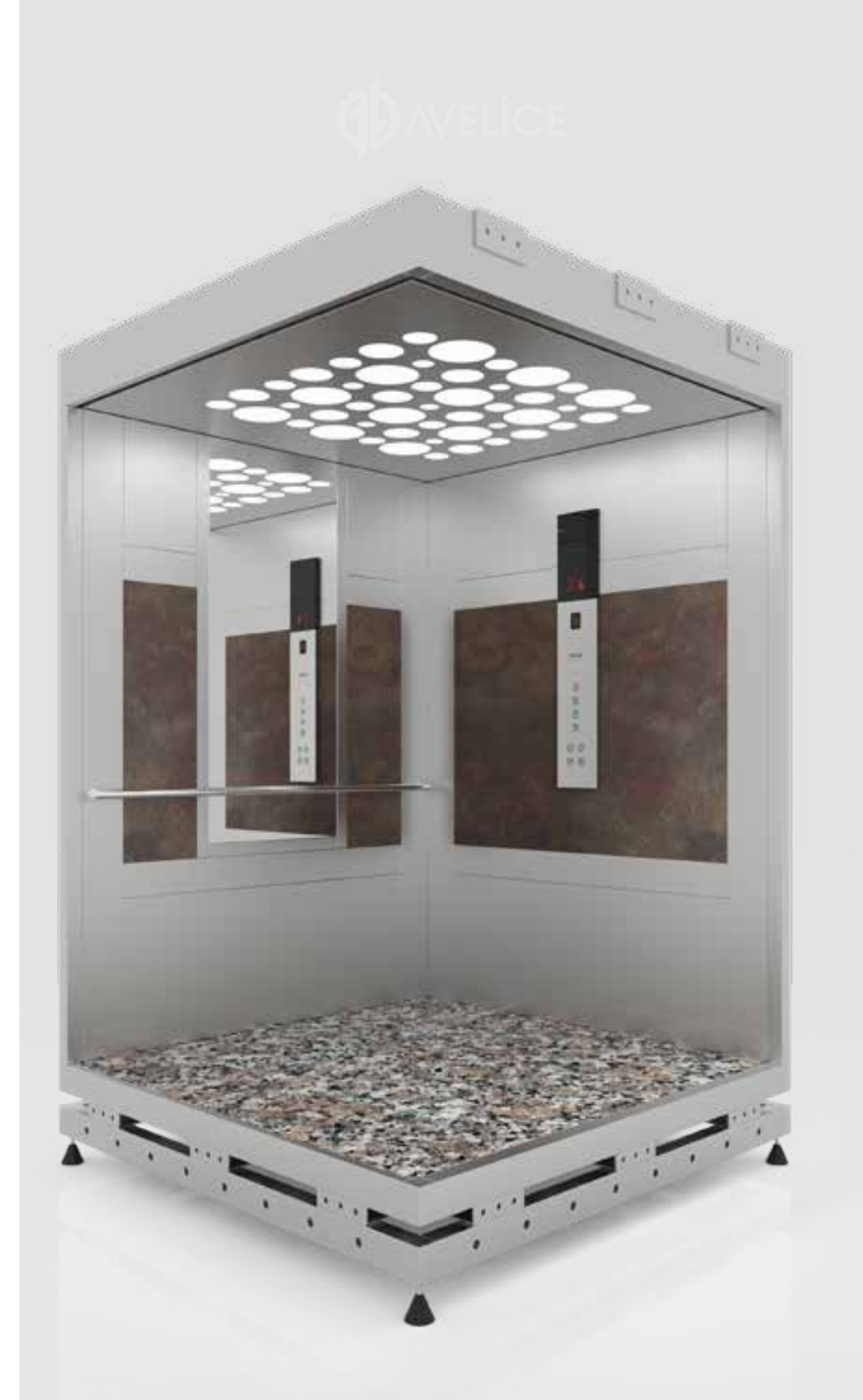



2070 Series

DETAYLAR

Kaplama	: Laminat
Aksesuar	: Paslanmaz
Tavan	: Lazer Kesim
Zemin	: Granit
Ayna	: Çerçeveli Ayna

DETAIL

Covering	: Laminate
Accessory	: Stainless Steel
Ceiling	: Laser Cutting
Floor	: Granite
Mirror	: Framed Mirror

ДЕТАЛИ

Покрытие	: Ламинат
Аksesуар	: Нержавеющая сталь
Потолок	: Лазерная резка
Пол	: Гранит
Зеркало	: Зеркало в раме

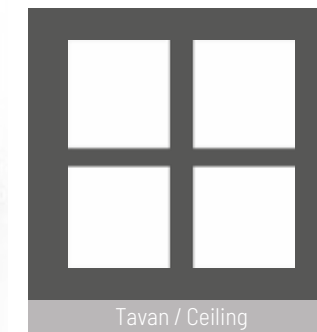



2080 Series

DETAYLAR

Kaplama	: Laminat + Nokta Paslanmaz
Aksesuar	: Paslanmaz
Tavan	: Lazer Kesim
Zemin	: Granit
Ayna	: Tam Boy

DETAIL

Covering	: Laminate + Dot Stainless Steel
Accessory	: Stainless Steel
Ceiling	: Laser Cutting
Floor	: Granite
Mirror	: Full Size

ДЕТАЛИ

Покрытие	: Ламинат + точечная нержавеющая сталь
Аksesуар	: Нержавеющая сталь
Потолок	: Лазерная резка
Пол	: Гранит
Зеркало	: Полный размер

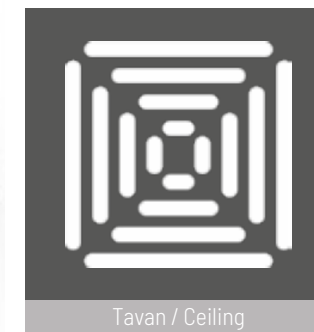



2090 Series

DETAYLAR

Kaplama	: Paslanmaz
Aksesuar	: Paslanmaz
Tavan	: Lazer Kesim
Zemin	: Granit
Ayna	: Tam Boy

DETAIL

Covering	: Stainless Steel
Accessory	: Stainless Steel
Ceiling	: Laser Cutting
Floor	: Granite
Mirror	: Full Size

ДЕТАЛИ

Покрытие	: Нержавеющая сталь
Аksesуар	: Нержавеющая сталь
Потолок	: Лазерная резка
Пол	: Гранит
Зеркало	: Полный размер





2100 Series

DETAYLAR

Kaplama	: Nokta Paslanmaz
Aksesuar	: Paslanmaz
Tavan	: Lazer Kesim
Zemin	: Granit
Ayna	: Tam Boy

DETAIL

Covering	: Dot Stainless Steel
Accessory	: Stainless Steel
Ceiling	: Laser Cutting
Floor	: Granite
Mirror	: Full Size

ДЕТАЛИ

Покрытие	: Точка из нержавеющей стали
Аksesуар	: Нержавеющая сталь
Потолок	: Лазерная резка
Пол	: Гранит
Зеркало	: Полный размер

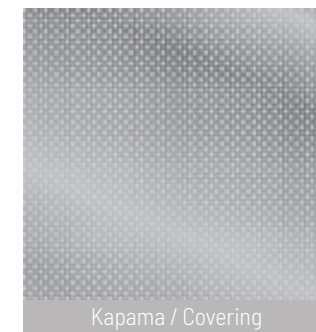
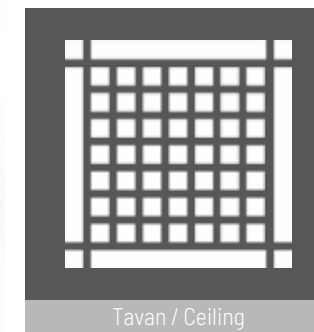



2120 Series

DETAYLAR

Kaplama	: Dekoratif Paslanmaz
Aksesuar	: Paslanmaz
Tavan	: Lazer Kesim
Zemin	: Granit
Ayna	: Tam Boy

DETAIL

Covering	: Decorative Stainless Steel
Accessory	: Stainless Steel
Ceiling	: Laser Cutting
Floor	: Granite
Mirror	: Full Size

ДЕТАЛИ

Покрытие	: Декоративная нержавеющая сталь
Аksesуар	: Нержавеющая сталь
Потолок	: Лазерная резка
Пол	: Гранит
Зеркало	: Полный размер

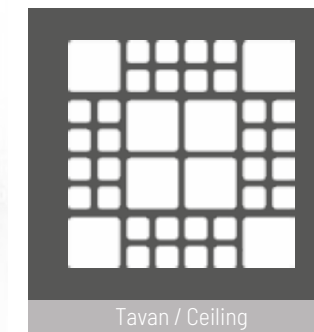



2130 Series

DETAYLAR

Kaplama	: Dekoratif Paslanmaz
Aksesuar	: Paslanmaz
Tavan	: Lazer Kesim
Zemin	: Granit
Ayna	: Tam Boy

DETAIL

Covering	: Decorative Stainless Steel
Accessory	: Stainless Steel
Ceiling	: Laser Cutting
Floor	: Granite
Mirror	: Full Size

ДЕТАЛИ

Покрытие	: Декоративная нержавеющая сталь
Аksesуар	: Нержавеющая сталь
Потолок	: Лазерная резка
Пол	: Гранит
Зеркало	: Полный размер

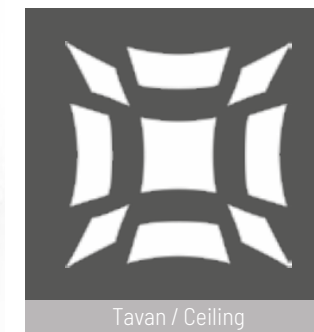



2140 Series

DETAYLAR

Kaplama	: Paslanmaz
Aksesuar	: Paslanmaz
Tavan	: Lazer Kesim
Zemin	: Granit
Ayna	: Tam Boy

DETAIL

Covering	: Stainless Steel
Accessory	: Stainless Steel
Ceiling	: Laser Cutting
Floor	: Granite
Mirror	: Full Size

ДЕТАЛИ

Покрытие	: Нержавеющая сталь
Аksesуар	: Нержавеющая сталь
Потолок	: Лазерная резка
Пол	: Гранит
Зеркало	: Полный размер

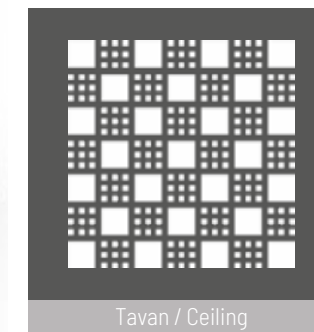



2150 Series

DETAYLAR

Kaplama	: Nokta Paslanmaz
Aksesuar	: Paslanmaz
Tavan	: Lazer Kesim
Zemin	: Granit
Ayna	: Tam Boy

DETAIL

Covering	: Dot Stainless Steel
Accessory	: Stainless Steel
Ceiling	: Laser Cutting
Floor	: Granite
Mirror	: Full Size

ДЕТАЛИ

Покрытие	: Точка из нержавеющей стали
Аksesуар	: Нержавеющая сталь
Потолок	: Лазерная резка
Пол	: Гранит
Зеркало	: Полный размер

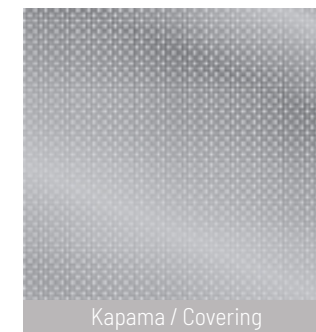
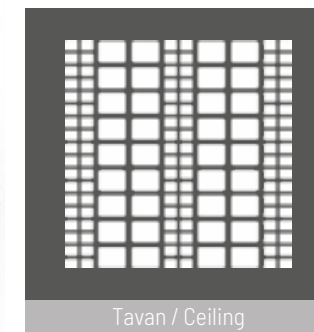



2160 Series

DETAYLAR

Kaplama	: Dekoratif Paslanmaz
Aksesuar	: Paslanmaz
Tavan	: Lazer Kesim
Zemin	: Granit
Ayna	: Tam Boy

DETAIL

Covering	: Decorative Stainless Steel
Accessory	: Stainless Steel
Ceiling	: Laser Cutting
Floor	: Granite
Mirror	: Full Size

ДЕТАЛИ

Покрытие	: Декоративная нержавеющая сталь
Аksesуар	: Нержавеющая сталь
Потолок	: Лазерная резка
Пол	: Гранит
Зеркало	: Полный размер

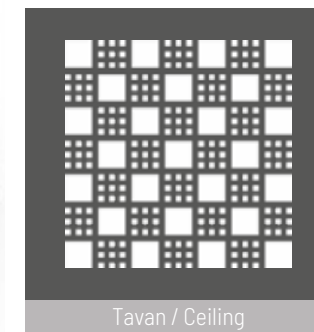



2170 Series

DETAYLAR

Kaplama	: Dekoratif Paslanmaz
Aksesuar	: Paslanmaz
Tavan	: Lazer Kesim
Zemin	: Granit
Ayna	: Tam Boy

DETAIL

Covering	: Decorative Stainless Steel
Accessory	: Stainless Steel
Ceiling	: Laser Cutting
Floor	: Granite
Mirror	: Full Size

ДЕТАЛИ

Покрытие	: Декоративная нержавеющая сталь
Аksesуар	: Нержавеющая сталь
Потолок	: Лазерная резка
Пол	: Гранит
Зеркало	: Полный размер

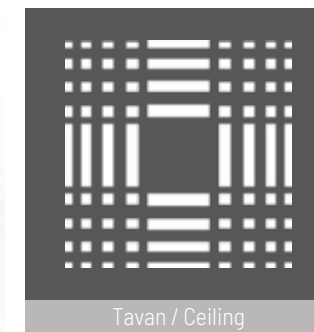



2180 Series

DETAYLAR

Kaplama	: Dekoratif Paslanmaz
Aksesuar	: Paslanmaz
Tavan	: Lazer Kesim
Zemin	: Granit
Ayna	: Tam Boy

DETAIL

Covering	: Decorative Stainless Steel
Accessory	: Stainless Steel
Ceiling	: Laser Cutting
Floor	: Granite
Mirror	: Full Size

ДЕТАЛИ

Покрытие	: Декоративная нержавеющая сталь
Аksesуар	: Нержавеющая сталь
Потолок	: Лазерная резка
Пол	: Гранит
Зеркало	: Полный размер

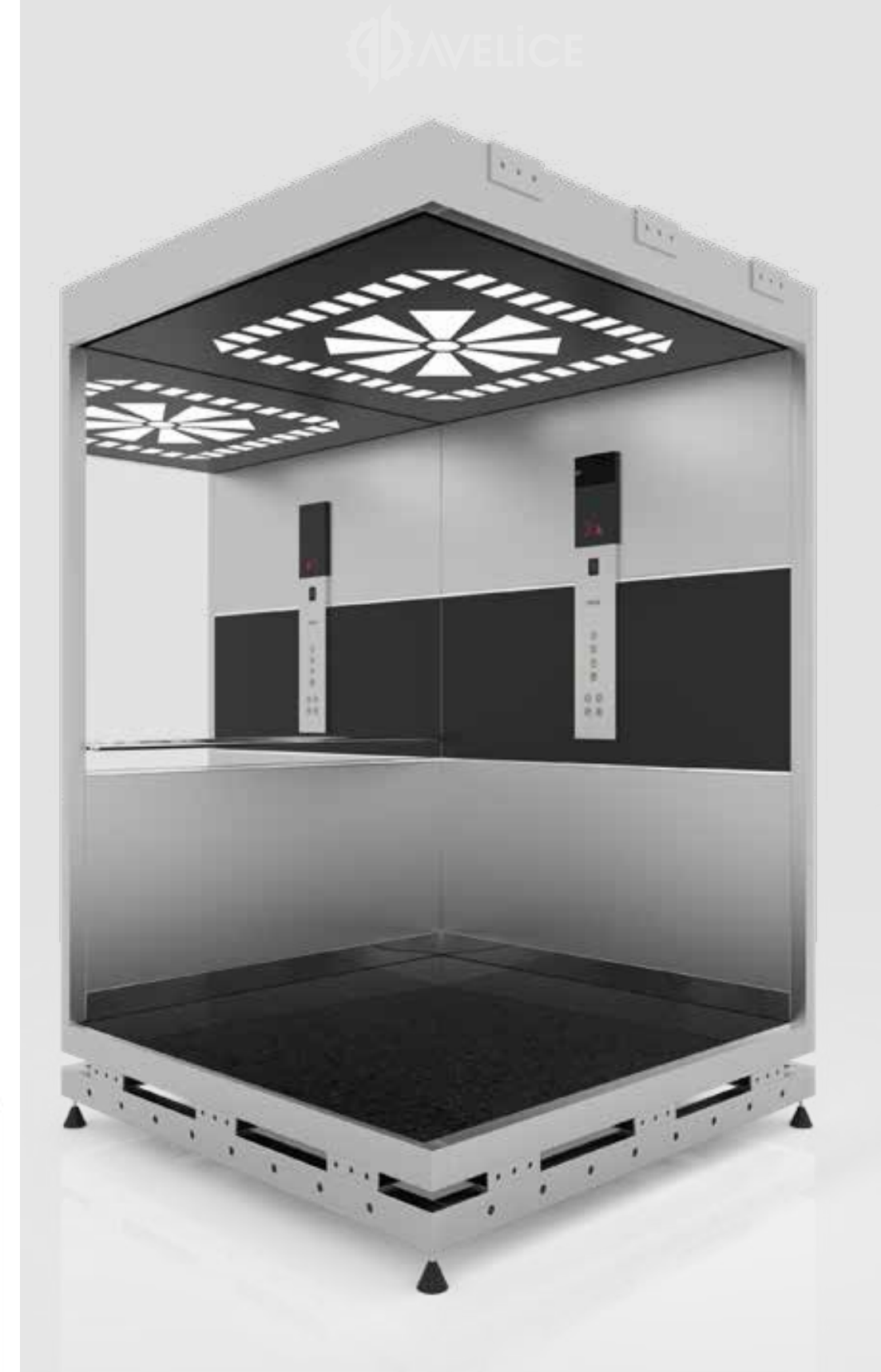



2190 Series

DETAYLAR

Kaplama	: Boyalı Sac
Aksesuar	: Paslanmaz
Tavan	: Lazer Kesim
Zemin	: Granit
Ayna	: Tam Boy

DETAIL

Covering	: Painted Steel
Accessory	: Stainless Steel
Ceiling	: Laser Cutting
Floor	: Granite
Mirror	: Full Size

ДЕТАЛИ

Покрытие	: Окрашенная сталь
Аксессуар	: Нержавеющая сталь
Потолок	: Лазерная резка
Пол	: Гранит
Зеркало	: Полный размер

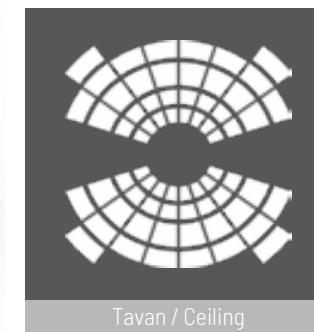

Tavan / Ceiling



Kaplama / Covering



Zemin / Floor



2200 Series

DETAYLAR

Kaplama	: Dekoratif Paslanmaz
Aksesuar	: Paslanmaz
Tavan	: Lazer Kesim
Zemin	: Granit
Ayna	: Tam Boy

DETAIL

Covering	: Decorative Stainless Steel
Accessory	: Stainless Steel
Ceiling	: Laser Cutting
Floor	: Granite
Mirror	: Full Size

ДЕТАЛИ

Покрытие	: Декоративная нержавеющая сталь
Аksesуар	: Нержавеющая сталь
Потолок	: Лазерная резка
Пол	: Гранит
Зеркало	: Полный размер

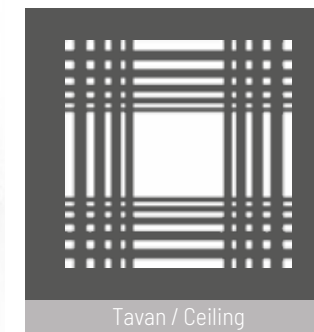



2210 Series

DETAYLAR

Kaplama	: Nokta Paslanmaz
Aksesuar	: Paslanmaz
Tavan	: Lazer Kesim
Zemin	: Granit
Ayna	: Tam Boy

DETAIL

Covering	: Dot Stainless Steel
Accessory	: Stainless Steel
Ceiling	: Laser Cutting
Floor	: Granite
Mirror	: Full Size

ДЕТАЛИ

Покрытие	: Точка из нержавеющей стали
Аksesуар	: Нержавеющая сталь
Потолок	: Лазерная резка
Пол	: Гранит
Зеркало	: Полный размер

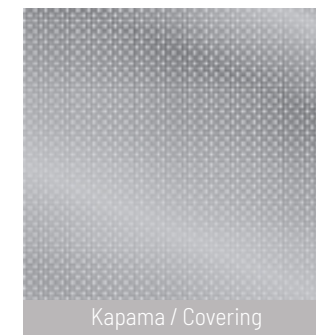
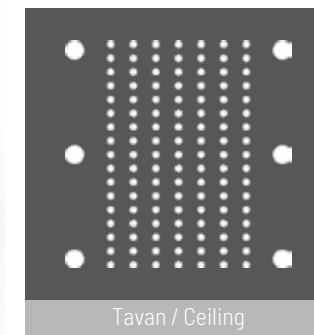



2220 Series

DETAYLAR

Kaplama	: Cam + Paslanmaz
Aksesuar	: Paslanmaz
Tavan	: Lazer Kesim
Zemin	: PVC
Ayna	: Tam Boy

DETAIL

Covering	: Glass + Stainless Steel
Accessory	: Stainless Steel
Ceiling	: Laser Cutting
Floor	: PVC
Mirror	: Full Size

ДЕТАЛИ

Покрытие	: Стекло + нержавеющая сталь
Аксессуар	: Нержавеющая сталь
Потолок	: Лазерная резка
Пол	: ПВХ
Зеркало	: Полный размер

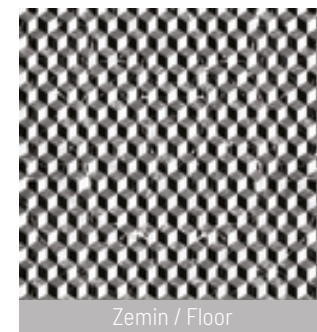
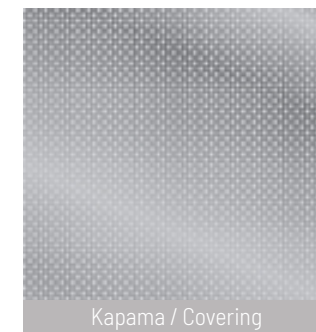
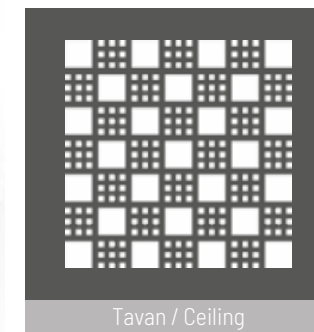



2230 Series



DETAYLAR

Kaplama	: Cam + Paslanmaz
Aksesuar	: Paslanmaz
Tavan	: Lazer Kesim
Zemin	: PVC
Ayna	: Tam Boy

DETAIL

Covering	: Glass + Stainless Steel
Accessory	: Stainless Steel
Ceiling	: Laser Cutting
Floor	: PVC
Mirror	: Full Size

ДЕТАЛИ

Покрытие	: Стекло + нержавеющая сталь
Аksesуар	: Нержавеющая сталь
Потолок	: Лазерная резка
Пол	: ПВХ
Зеркало	: Полный размер

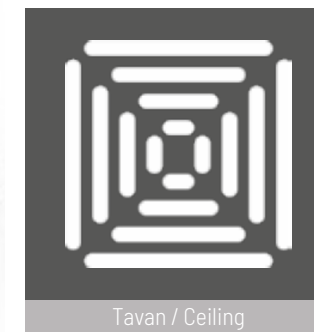
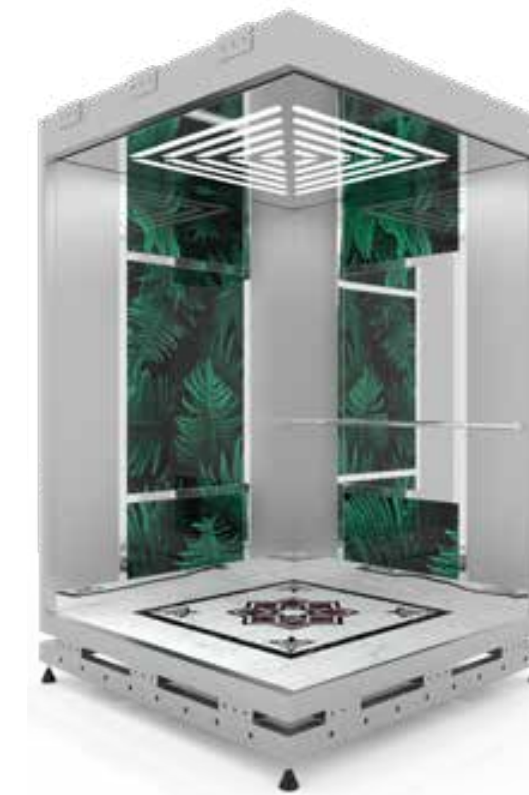



2240 Series

DETAYLAR

Kaplama	: Cam + Dekoratif Paslanmaz
Aksesuar	: Dekoratif Paslanmaz
Tavan	: Lazer Kesim
Zemin	: Granit
Ayna	: Tam Boy

DETAIL

Covering	: Glass + Decorative Stainless Steel
Accessory	: Decorative Stainless Steel
Ceiling	: Laser Cutting
Floor	: Granite
Mirror	: Full Size

ДЕТАЛИ

Покрытие	: Стекло + декоративная нержавеющая сталь
Аксесуар	: Декоративная нержавеющая сталь
Потолок	: Лазерная резка
Пол	: Гранит
Зеркало	: Полный размер

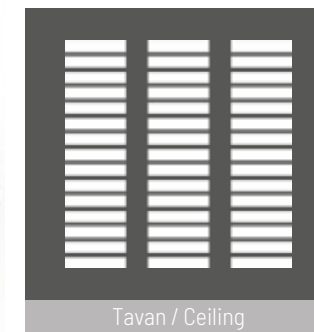



2250 Series

DETAYLAR

Kaplama	: Dekoratif Paslanmaz
Aksesuar	: Dekoratif Paslanmaz
Tavan	: Lazer Kesim
Zemin	: Granit
Ayna	: Tam Boy

DETAIL

Covering	: Decorative Stainless Steel
Accessory	: Decorative Stainless Steel
Ceiling	: Laser Cutting
Floor	: Granite
Mirror	: Full Size

ДЕТАЛИ

Покрытие	: Декоративная нержавеющая сталь
Аksesуар	: Декоративная нержавеющая сталь
Потолок	: Лазерная резка
Пол	: Гранит
Зеркало	: Полный размер

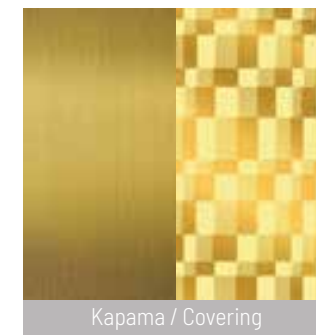
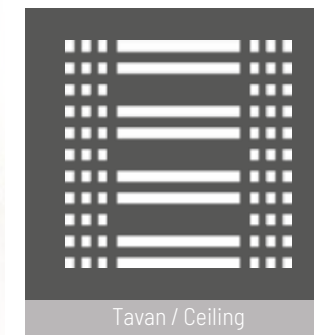



2260 Series

DETAYLAR

Kaplama	: Dekoratif Paslanmaz
Aksesuar	: Dekoratif Paslanmaz
Tavan	: Lazer Kesim
Zemin	: Granit
Ayna	: Tam Boy

DETAIL

Covering	: Decorative Stainless Steel
Accessory	: Decorative Stainless Steel
Ceiling	: Laser Cutting
Floor	: Granite
Mirror	: Full Size

ДЕТАЛИ

Покрытие	: Декоративная нержавеющая сталь
Аксессуар	: Декоративная нержавеющая сталь
Потолок	: Лазерная резка
Пол	: Гранит
Зеркало	: Полный размер

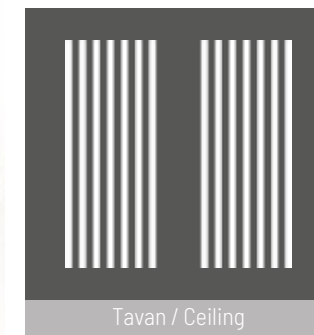



2270 Series

DETAYLAR

Kaplama	: Dekoratif Paslanmaz
Aksesuar	: Dekoratif Paslanmaz
Tavan	: Lazer Kesim
Zemin	: Granit
Ayna	: Tam Boy

DETAIL

Covering	: Decorative Stainless Steel
Accessory	: Decorative Stainless Steel
Ceiling	: Laser Cutting
Floor	: Granite
Mirror	: Full Size

ДЕТАЛИ

Покрытие	: Декоративная нержавеющая сталь
Аksesuar	: Декоративная нержавеющая сталь
Потолок	: Лазерная резка
Пол	: Гранит
Зеркало	: Полный размер

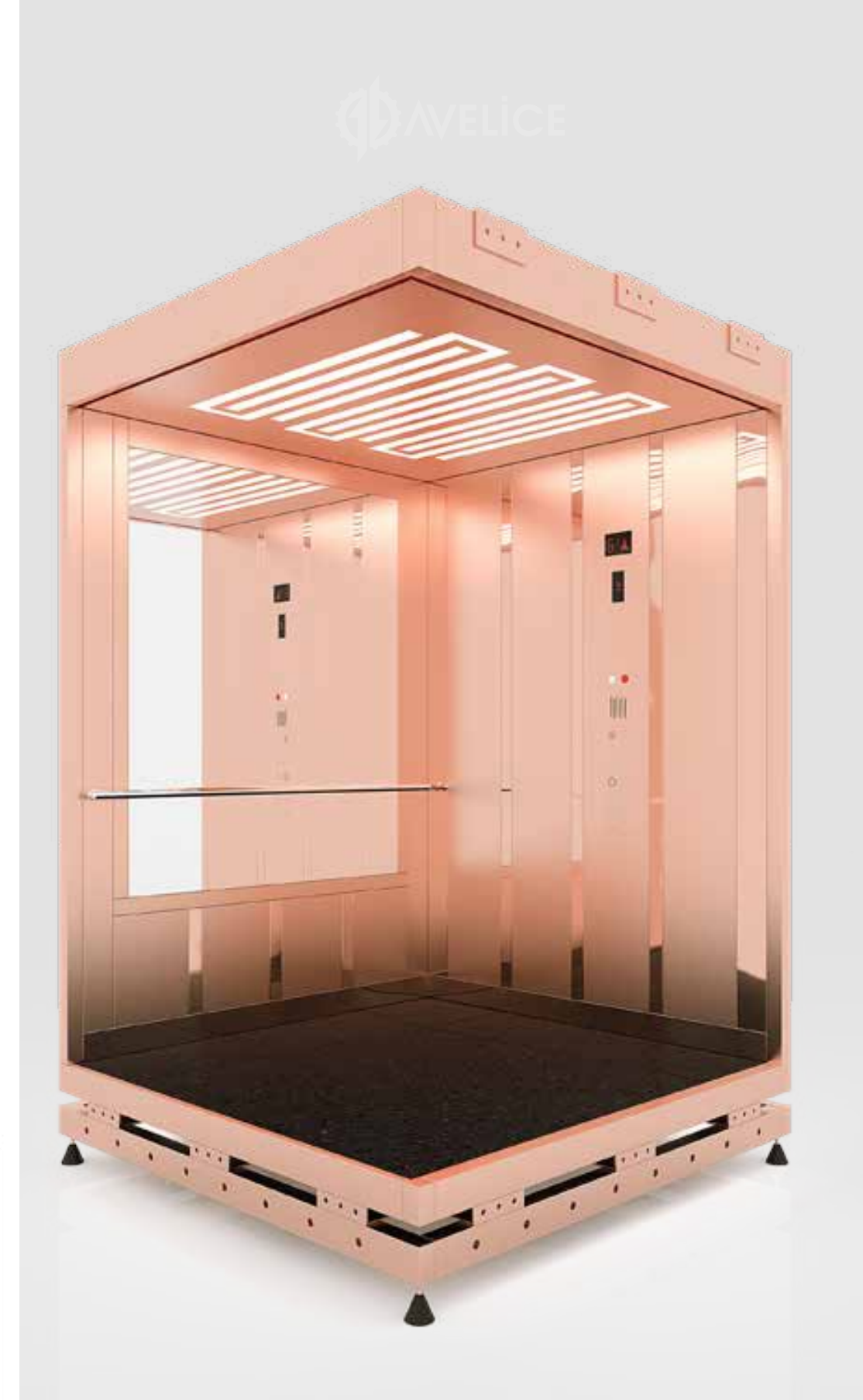



2280 Series

DETAYLAR

Kaplama	: Taş
Aksesuar	: Paslanmaz
Tavan	: Lazer Kesim
Zemin	: Granit
Ayna	: Tam Boy

DETAIL

Covering	: Stone
Accessory	: Stainless Steel
Ceiling	: Laser Cutting
Floor	: Granite
Mirror	: Full Size

ДЕТАЛИ

Покрытие	: Камень
Аксесуар	: Нержавеющая сталь
Потолок	: Лазерная резка
Пол	: Гранит
Зеркало	: Полный размер

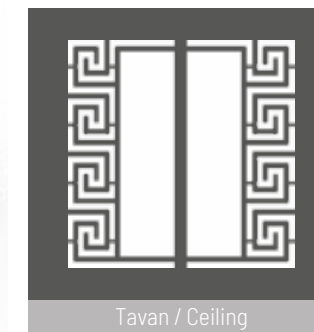



2290 Series

DETAYLAR

Kaplama	: Ahşap
Aksesuar	: Paslanmaz
Tavan	: Lazer Kesim
Zemin	: Granit
Ayna	: Tam Boy

DETAIL

Covering	: Wood
Accessory	: Stainless Steel
Ceiling	: Laser Cutting
Floor	: Granite
Mirror	: Full Size

ДЕТАЛИ

Покрытие	: Дерево
Аksesуар	: Нержавеющая сталь
Потолок	: Лазерная резка
Пол	: Гранит
Зеркало	: Полный размер

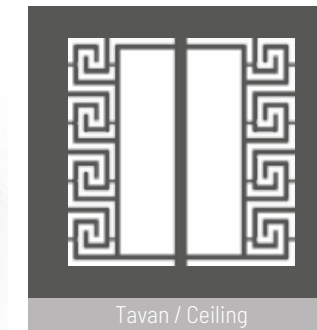
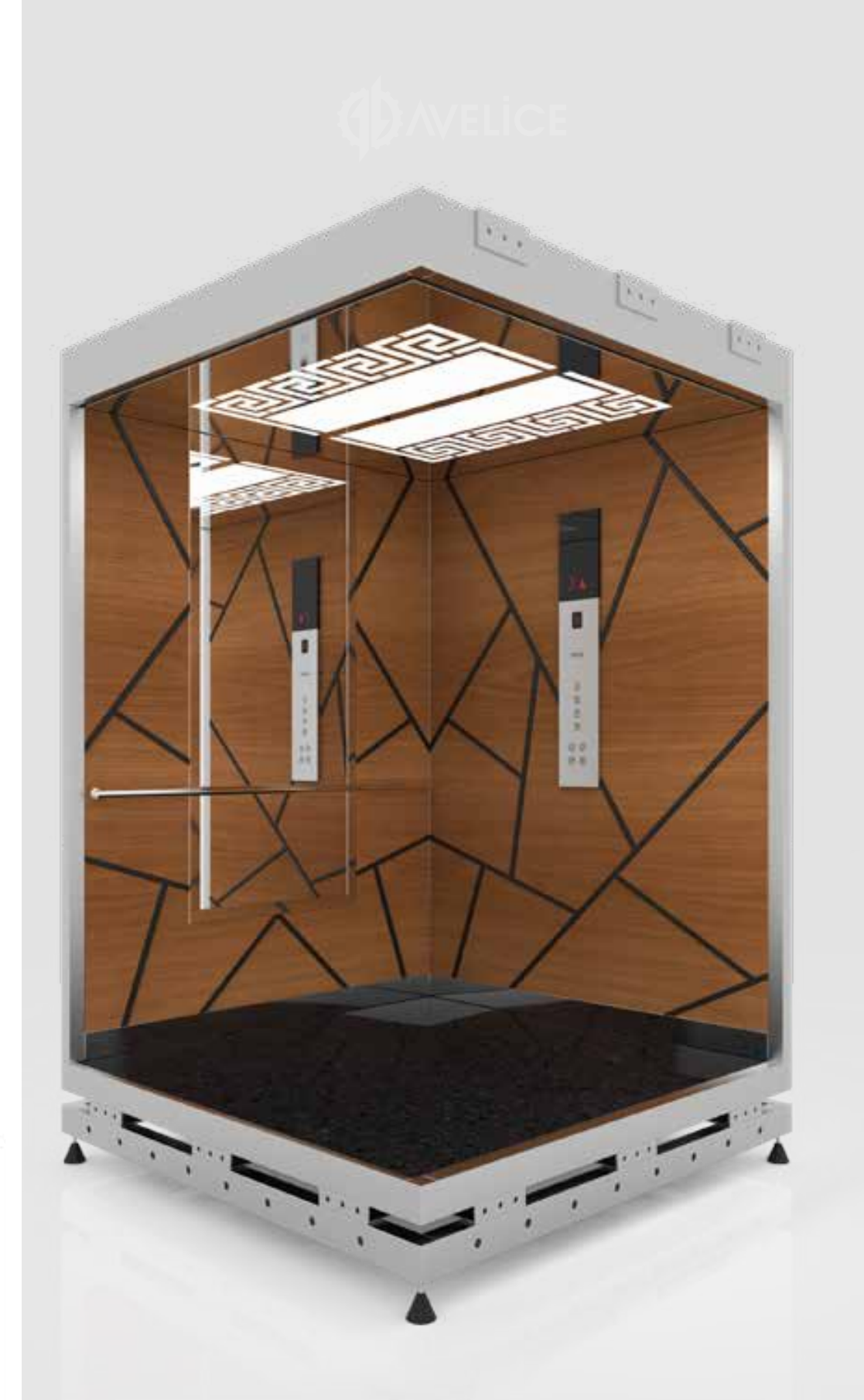



2300 Series

DETAYLAR

Kaplama	: Paslanmaz
Aksesuar	: Paslanmaz
Tavan	: Lazer Kesim
Zemin	: Granit

DETAIL

Covering	: Stainless Steel
Accessory	: Stainless Steel
Ceiling	: Laser Cutting
Floor	: Granite

ДЕТАЛИ

Покрытие	: Нержавеющая сталь
Аksesуар	: Нержавеющая сталь
Потолок	: Лазерная резка
Пол	: Гранит

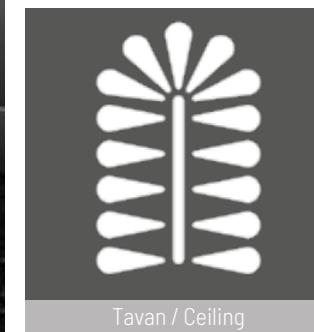



2310 Series



DETAYLAR

Kaplama	: Paslanmaz
Aksesuar	: Paslanmaz
Tavan	: Lazer Kesim
Zemin	: Granit

DETAIL

Covering	: Stainless Steel
Accessory	: Stainless Steel
Ceiling	: Laser Cutting
Floor	: Granite

ДЕТАЛИ

Покрытие	: Нержавеющая сталь
Аksesуар	: Нержавеющая сталь
Потолок	: Лазерная резка
Пол	: Гранит

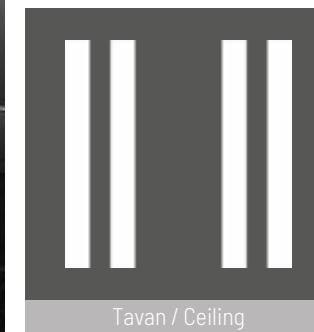

YANGIN ASANSÖRÜ

FIRE ELEVATOR

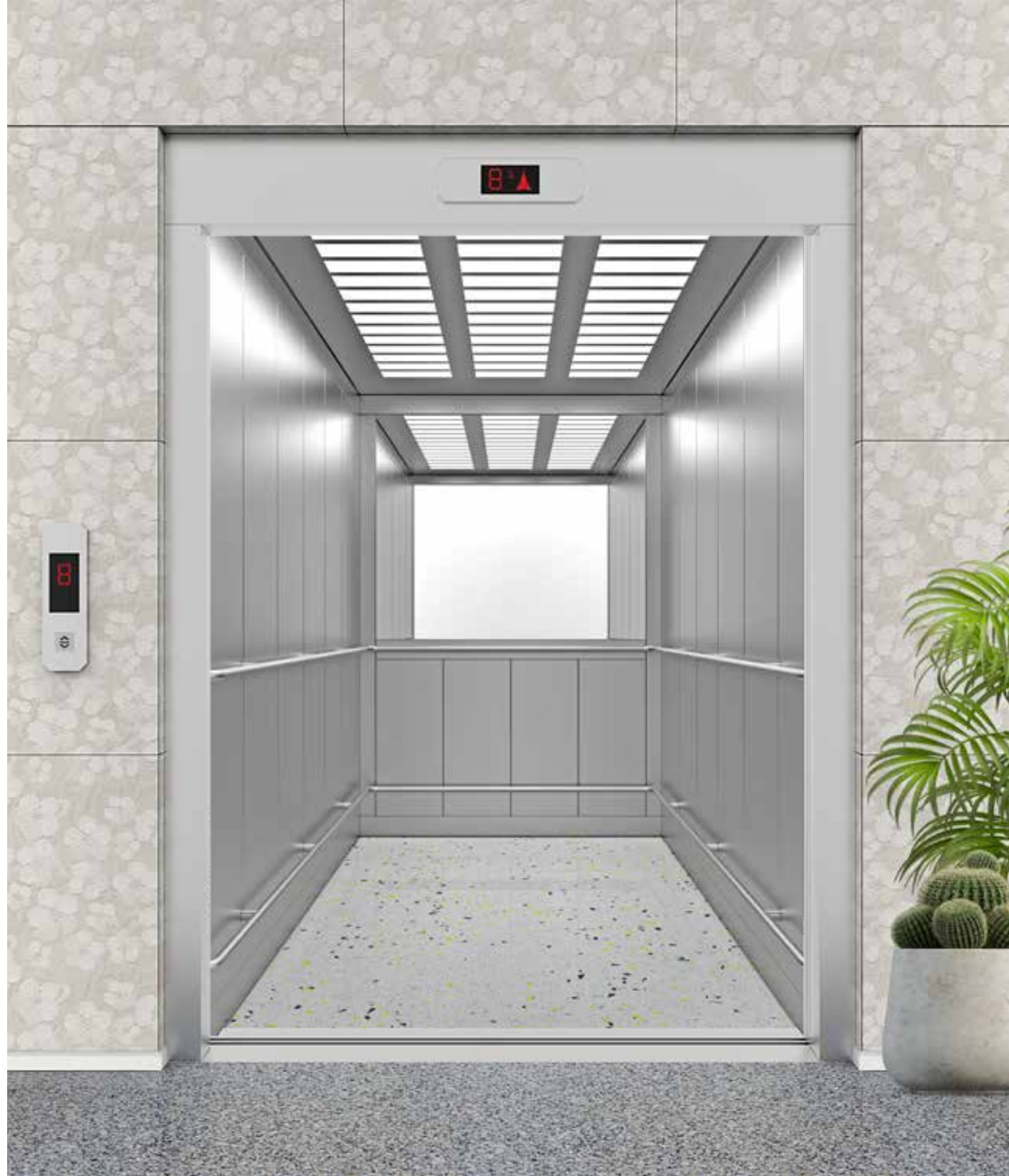

ARAÇ VE YÜK ASANSÖRÜ

VEHICLE AND FREIGHT LIFT

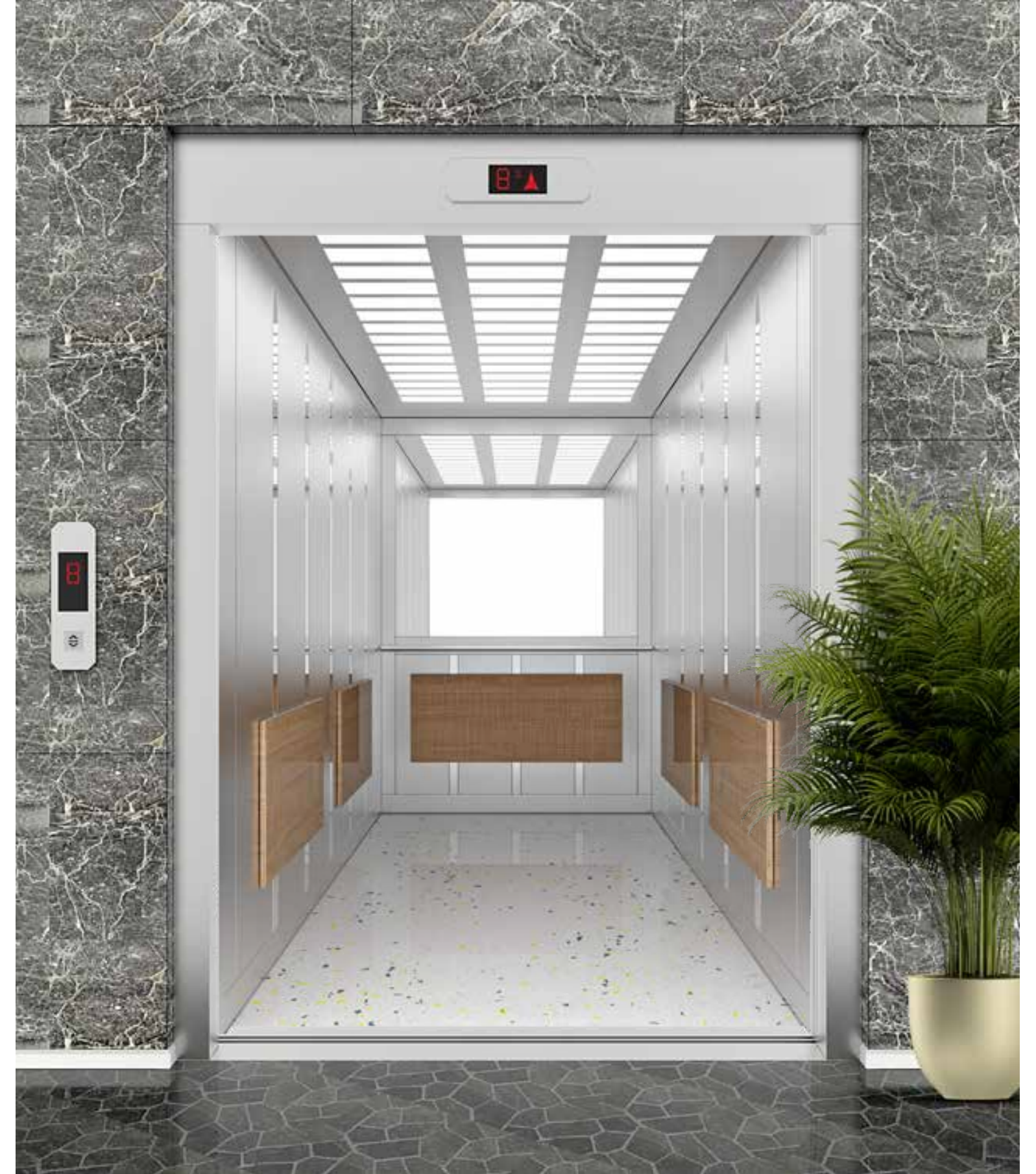

YANGIN ASANSÖRÜ

FIRE ELEVATOR



ARAÇ VE YÜK ASANSÖRÜ

VEHICLE AND FREIGHT LIFT

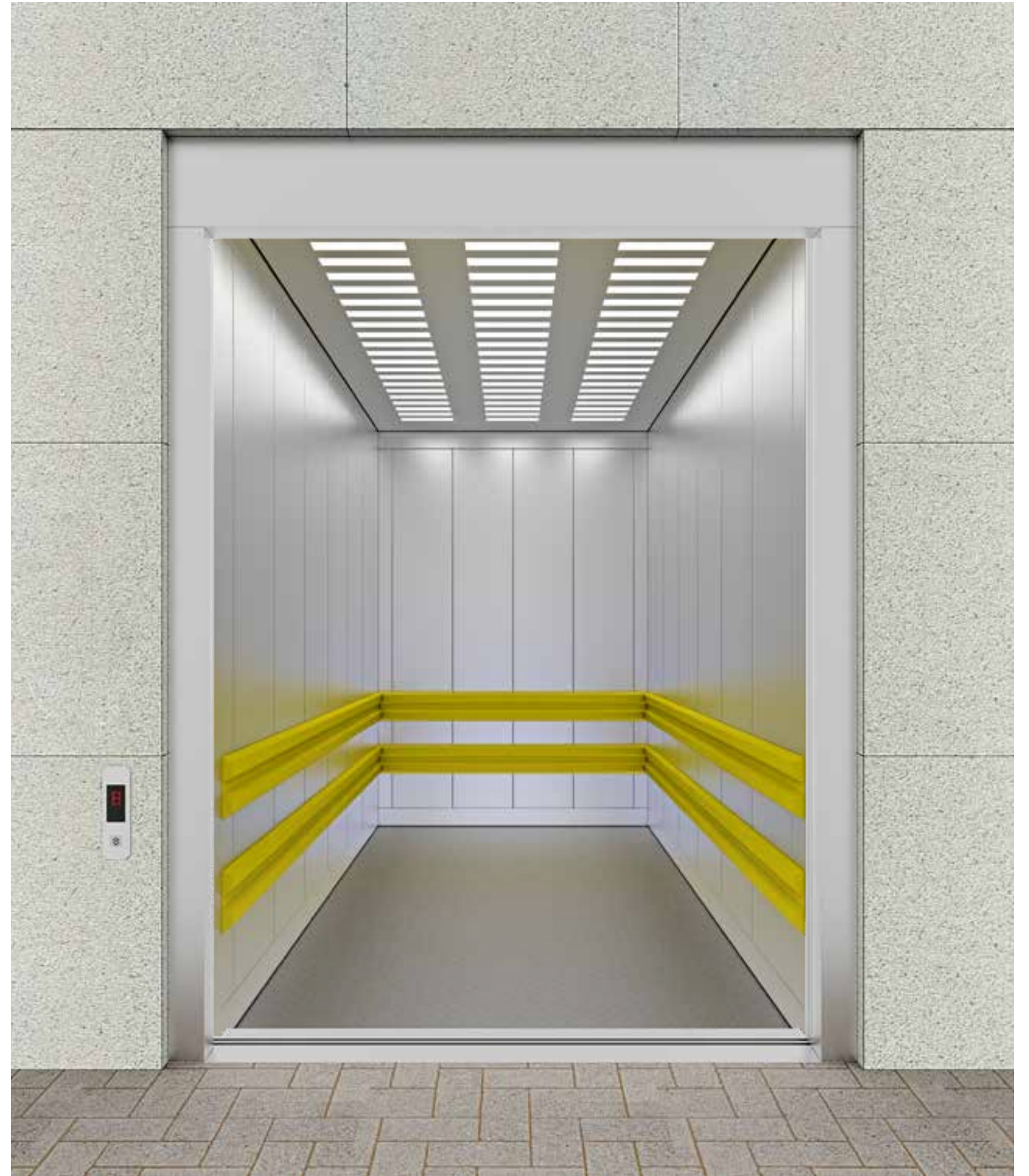



STANDART KAT KAPILARI

STANDARD FLOOR DOORS



2 Panel Merkezi Asansör Kapıları
2 Panel Central Elevator Door
2-х панельная центральная дверь лифта



2 Panel Teleskopik Asansör Kapıları
2 Panel Telescopic Elevator Door
2-х панельная телескопическая дверь лифта



3 Panel Teleskopik Asansör Kapıları
3 Panel Telescopic Elevator Door
3-х панельная телескопическая дверь лифта



4 Panel Merkezi Asansör Kapıları
4 Panel Central Elevator Door
4-х панельная центральная дверь лифта

DEKORATİF KAT KAPILARI

DECORATIVE FLOOR DOORS



2 Panel Merkezi Asansör Kapıları (Cam Panel)
2 Panel Central Elevator Door (Glass Panel)
2-х панельная центральная дверь лифта (стеклянная панель)



2 Panel Teleskopik Asansör Kapıları (Cam Panel)
2 Panel Telescopic Elevator Door (Glass Panel)
2-х панельная телескопическая дверь лифта (стеклянная панель)



DECORATIVE 01



DECORATIVE 02

AVELICE ELEVATOR FLOOR DOORS

AVELICE ELEVATOR FLOOR DOORS





DEKORATİF KAT KAPILARI

DECORATIVE FLOOR DOORS



DECORATIVE 03



DECORATIVE 04



DECORATIVE 05

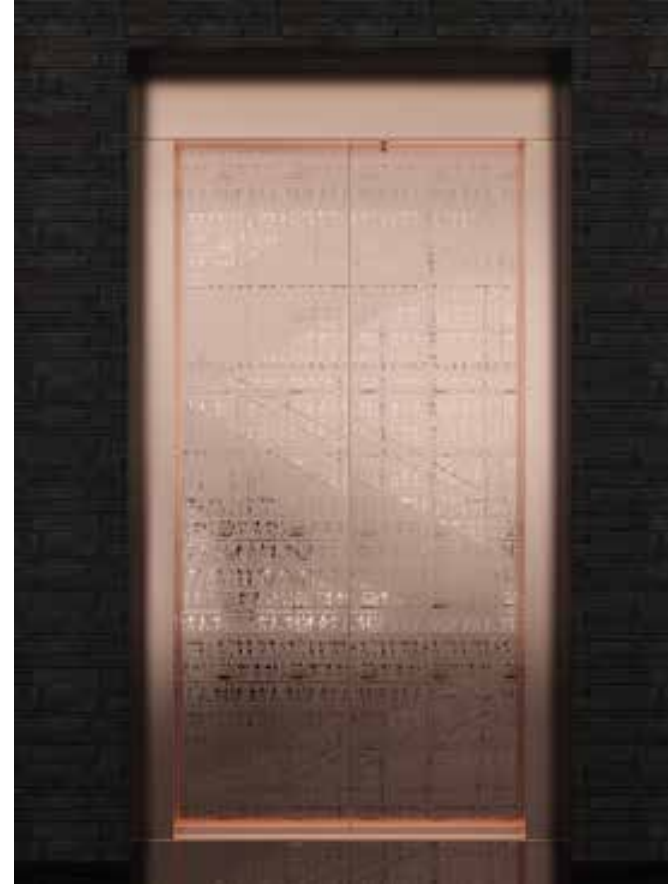

DECORATIVE 06

KAPI MEKANİZMALARI

DOOR MECHANISMS



- ▶ 2 Panel Merkezi Asansör Kapıları Mekanizmaları
2 Panel Central Elevator Door Mechanisms
- ▶ 2 Panel Teleskopik Asansör Kapıları Mekanizmaları
2 Panel Telescopic Elevator Door Mechanisms
- ▶ 3 Panel Teleskopik Asansör Kapıları Mekanizmaları
3 Panel Telescopic Elevator Door Mechanisms
- ▶ 4 Panel Merkezi Asansör Kapıları Mekanizmaları
4 Panel Central Elevator Door Mechanisms



AVELICE DOOR MECHANISMS



BUTON SEÇENEKLERİ

BUTTON OPTIONS

AVELICE COP-LOP OPTIONS



AT-B01



AT-B02



AT-Y01



AT-Y02



AT-K1



AT-K2



AT-K3



AT-K4



AT-K5



AT-G1



AT-G2

BUTON SEÇENEKLERİ

BUTTON OPTIONS



AVELICE COP-LOP OPTIONS



BT-B01



BT-B02



BT-B03



BT-Y01



BT-Y02



BT-K1



BT-K2



BT-K3



BT-K4



BT-K5



BT-H1



BT-G1



BT-G2



MOTOR SEÇENEKLERİ

MOTOR OPTIONS



AKIS



AKIS



AKIS



AKIS



AKIS



EMF



CSAG



ALBERTO SASSI



ALBERTO SASSI



EKER



EKER



EKER



MOTOR SEÇENEKLERİ

MOTOR OPTIONS



WITTUR



GEM



GEM



MONTANARI

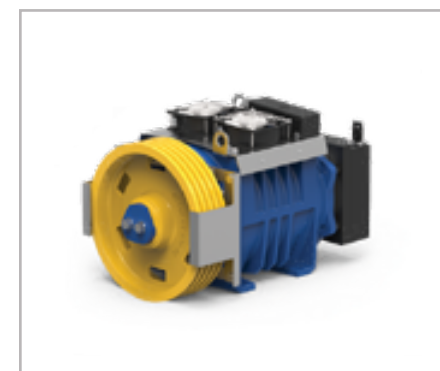

MONTANARI



NAGEL



SICOR



SICOR



KINETEK



METROPLAST



AKAR



AKAR

AVELICE MOTOR OPTIONS

AVELICE MOTOR OPTIONS



KONTROL PANOSU ve SÜRÜCÜ SEÇENEKLERİ

CONTROL PANEL & DRIVER OPTIONS



ARCUBE



ARCODE



ADRIVE

KONTROL PANOSU ve SÜRÜCÜ SEÇENEKLERİ

CONTROL PANEL & DRIVER OPTIONS



DELTA



HEDEFSAN



ML-COMBO



CONTROL PANEL & DRIVERS

CONTROL PANEL & DRIVERS





SÜSPANSİYON SEÇENEKLERİ

SUSPENSION OPTIONS

AVELICE CARRIER OPTIONS

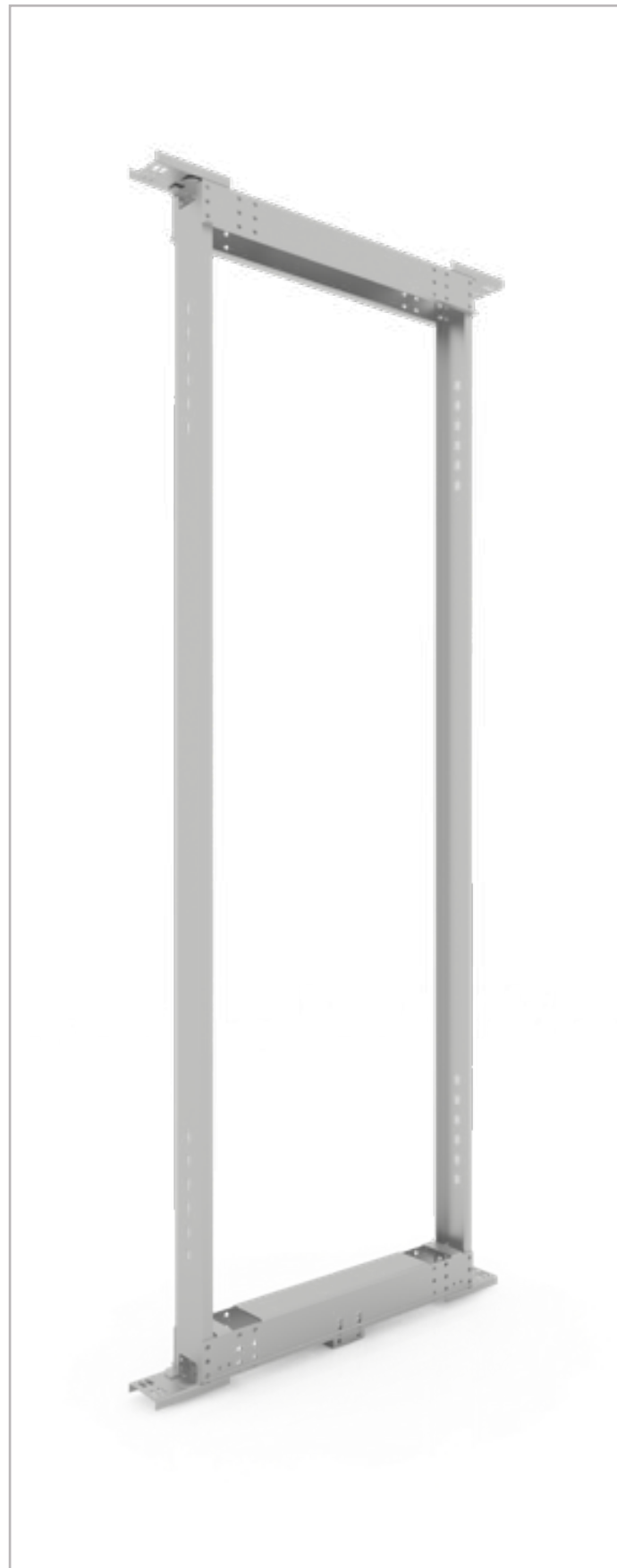

AVL-KR-01

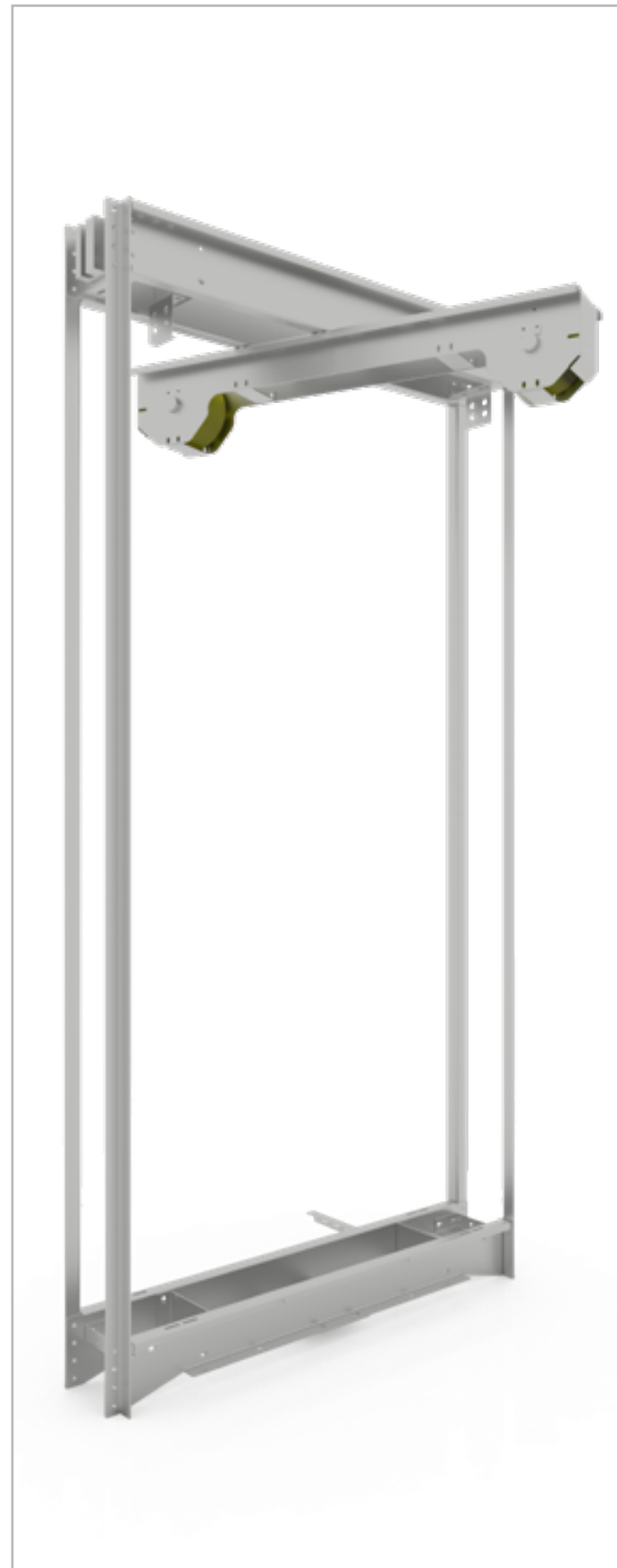

AVL-KR-02

SÜSPANSİYON SEÇENEKLERİ

SUSPENSION OPTIONS



AVELICE CARRIER OPTIONS

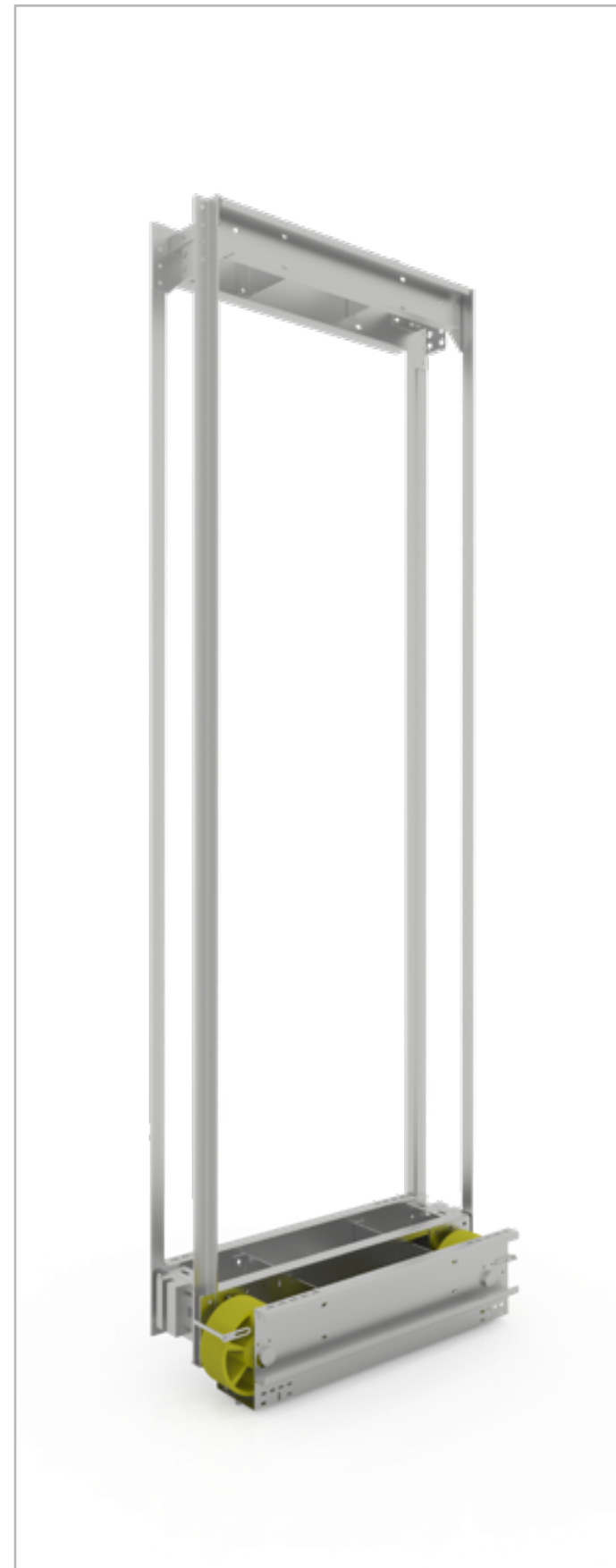

AVL-KR-03

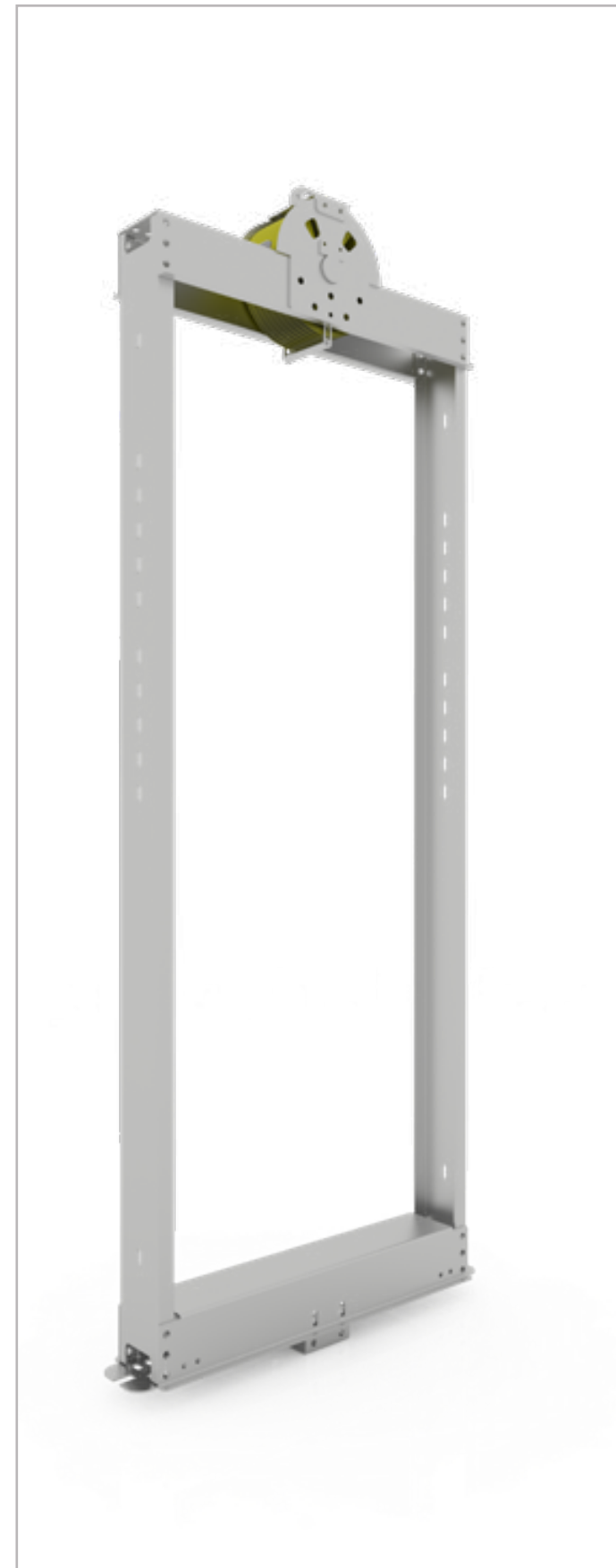

AVL-KR-04



HAZIR TESİSAT

FAST INSTALLATION

FAST INSTALLATION

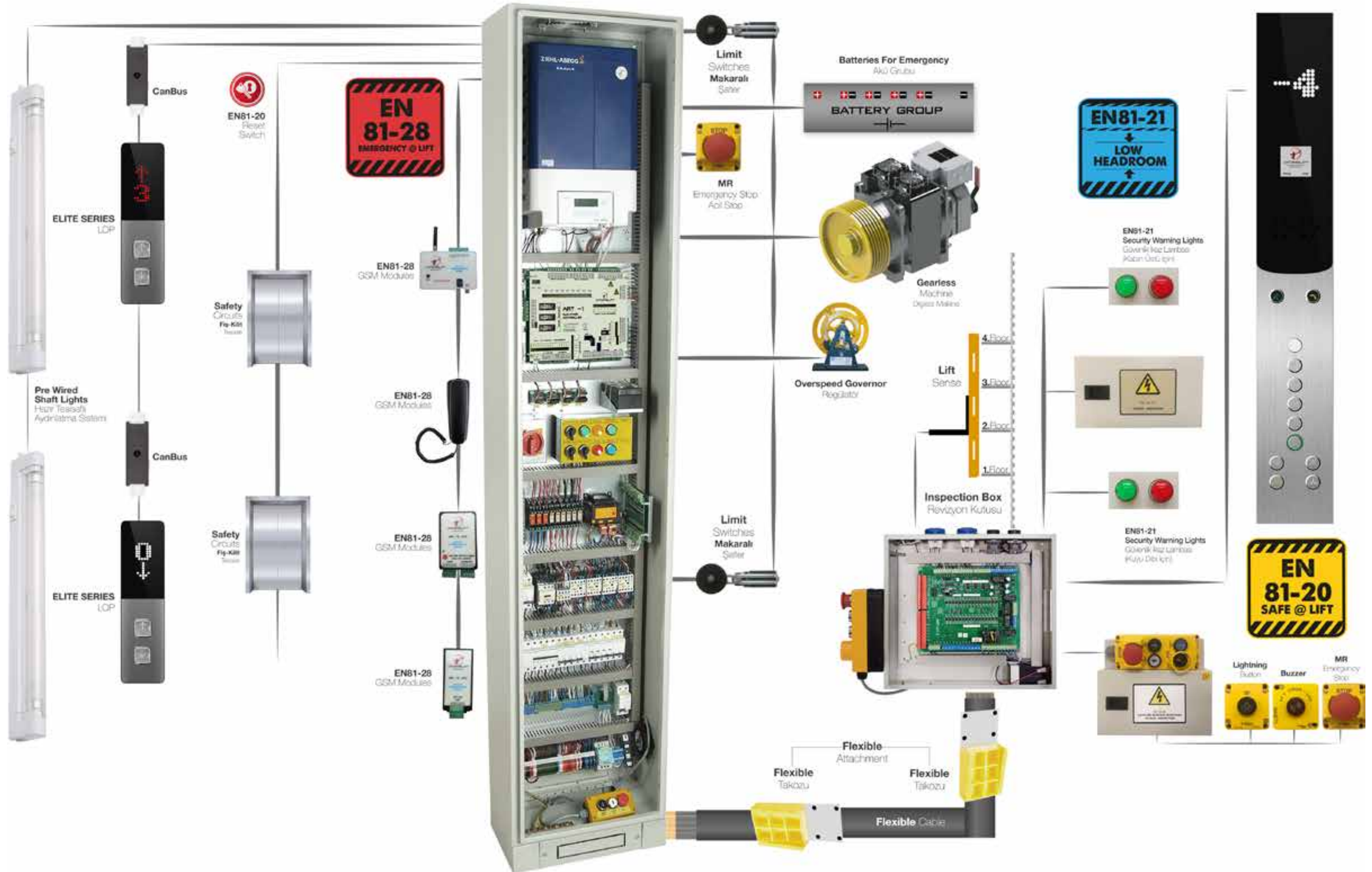

HAZIR TESİSAT

FAST INSTALLATION



FAST INSTALLATION



MRL SİSTEM

MRL SYSTEM

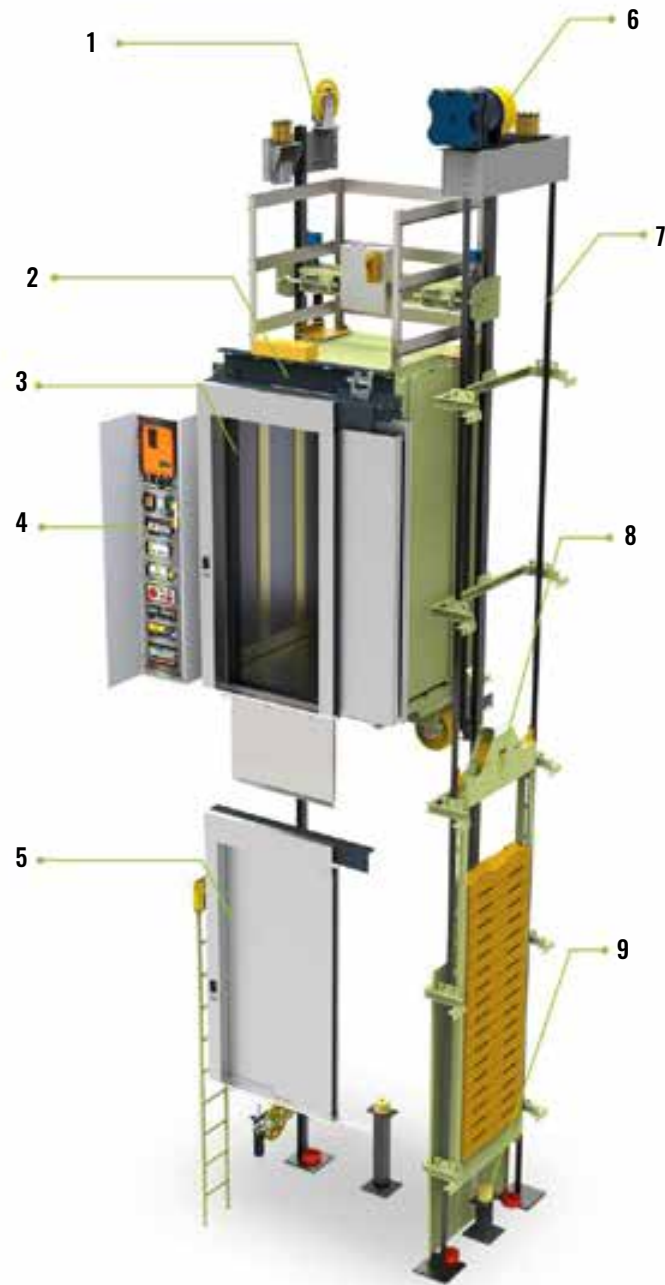

- 1 : Regülâtör
- 2 : Kabin Kapısı
- 3 : Kabin
- 4 : Kontrol Panosu
- 5 : Kat Kapısı
- 6 : Makine
- 7 : Ray
- 8 : Karşı Ağırlık
- 9 : Tampon

- 1 : Regulator
- 2 : Cabin Door
- 3 : Cabin
- 4 : Control Panel
- 5 : Landing Door
- 6 : Machine
- 7 : Rail
- 8 : Counterweight
- 9 : Buffer

MRL Sistem

Kuyuya açılan bir kapı ile tüm sisteme müdahale etmek mümkündür. Dişlisiz makinelerin kullanımı ile makine dairelerine ihtiyaç kalmamıştır. Frekans kontrollü makinemiz ile kalkış ve duruşlarda konfor, kat ayarlarında hassasiyet maksimum seviyeye ulaşmıştır. Geleneksel motorlara kıyasla %40'a varan enerji tasarrufuna ek olarak, dişli kutusu olmaması nedeniyle aşınma son derece düşüktür. Sistemin tamamen yağsız olması çevre kirliliği ve yangın riski olmaması

MRL System

it is possible to intervene in the entire system via a door opening to the well. With the usage of Gearless machines there is no more a necessity for machine rooms. With our frequency-controlled machine, comfort in take-offs and stops and sensitivity in floor settings have reached the maximum. In addition to energy savings of up to 40% compared to conventional motors, wear is extremely low due to the absence of a gearbox. The fact that the system is completely oil-free there is no environmental pollution and risk of fire

MR SİSTEM

MR SYSTEM

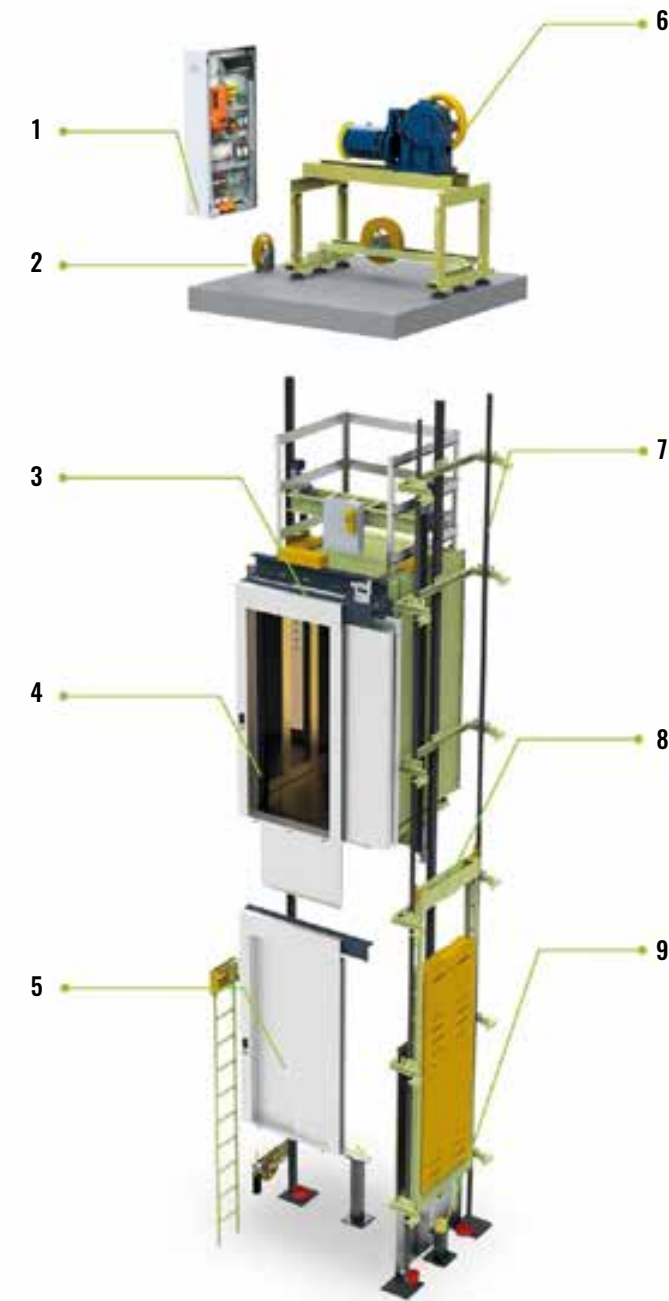

- 1 : Kontrol Panosu
- 2 : Regülâtör
- 3 : Kabin Kapısı
- 4 : Kabin
- 5 : Kat Kapısı
- 6 : Makine
- 7 : Ray
- 8 : Karşı Ağırlık
- 9 : Tampon

- 1 : Control Panel
- 2 : Regulator
- 3 : Cabin Door
- 4 : Cabin
- 5 : Landing Door
- 6 : Machine
- 7 : Rail
- 8 : Counterweight
- 9 : Buffer

MR Sistem

Asansör boşluğu dışında makine dairesi de bulunmaktadır. Makine dairesine açılan bir kapı ile tüm sisteme müdahale etmek mümkündür. Makine dairesi asansörlerde hem Dişlisiz hem de dişli makineler kullanılmaktadır. Frekans kontrollü makinemiz ile kalkış ve duruşlarda konfor, kat ayarlarında hassasiyet maksimum seviyeye ulaşmıştır. Klasik motorlara göre %40'a varan enerji tasarrufu sağlar. Redüktörlü motor kullanıldığında yağ bakımı periyodik olarak yapılmalıdır.

MR System

Apart from the elevator shaft, there is also a machine room. It is possible to intervene in the whole system through a door to the engine room. Both Gearless and geared machines are used in elevators that have machine rooms. With our frequency-controlled machine, comfort in take-offs and stops and sensitivity in floor settings have reached the maximum. It provides energy savings of up to 40% compared to conventional motors. Oil maintenance should be done periodically when geared motor is used.



AVELICE MR SYSTEM



HİDROLİK SİSTEM

HYDRAULIC SYSTEM

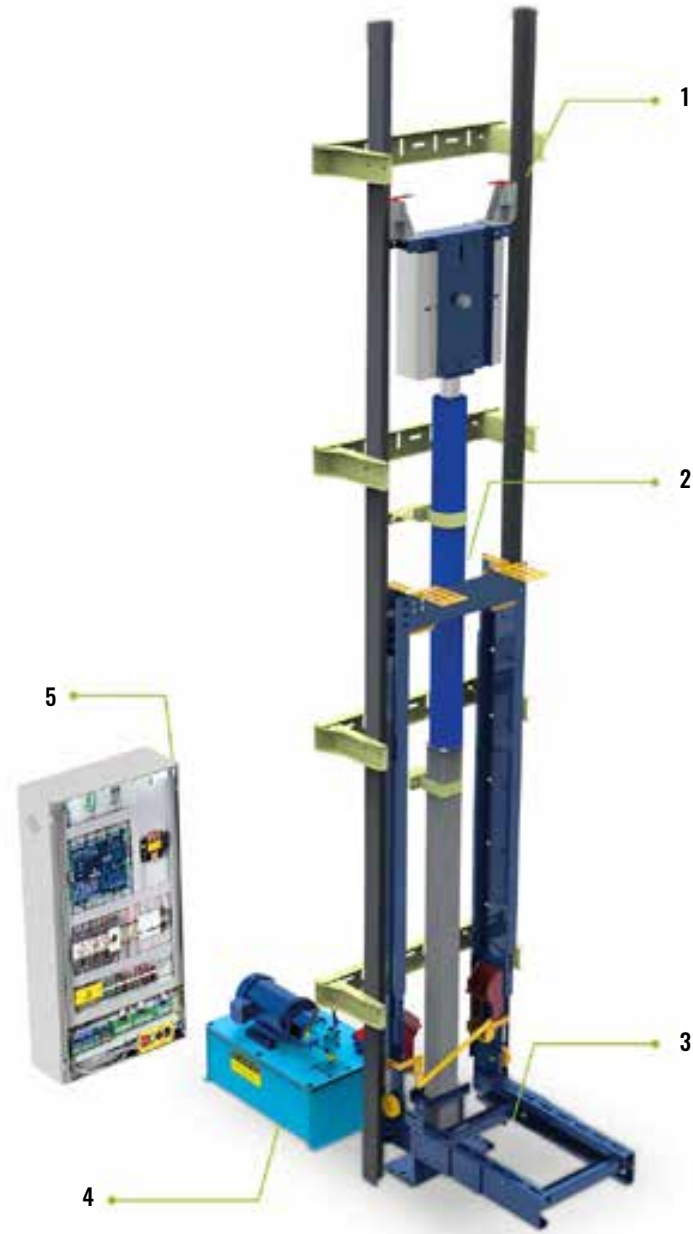

- 1 : Ray
- 2 : Silindir
- 3 : Kabin Karkası
- 4 : Hidrolik Pompa
- 5 : Kontrol Panosu

- 1 : Rail
- 2 : Cylinder
- 3 : Cabin Frame
- 4 : Hydraulic Pump
- 5 : Control Panel

Hidrolik Sistemler

Kaldırma işi, kabini doğrudan veya dolaylı olarak etkileyen bir kaldırıcıya hidrolik sıvı sağlayan elektrikle çalışan bir pompa vasıtasıyla gerçekleştirilir. Bu asansörlerde aşağı doğru hareket kabinin ağırlığı ile gerçekleşir. Hidrolik asansörlerde makine dairesi genellikle ilk durak seviyesinde yer alır. Yağ kazanı ve hidrolik makine (montaj), kumanda panosu ve hidrolik akışkanın geçtiği hortumlar bulunmaktadır. Asansör boşluğunun içindeki bileşenler: kabin, karşı ağırlık (varsa), silindir-piston sistemi, süspansiyon tertibatı ve tamponlardır.

Pompanan yağ, belirli şartları yerine getirerek hidrolik makineden geçer ve borular vasıtasıyla silindire harekete geçirir. Silindir doğrudan veya dolaylı olarak kabine bağlanabilir. Silindirin ittiği kabin, alınan kumanda ile istenilen kata hareket ettirilir.

Hydraulic System

Lifting work is carried out by means of an electrically driven pump that delivers hydraulic fluid to a lifter that directly or indirectly affects the cabin. In these elevators, the downward movement is realized by the weight of the cabin. In hydraulic elevators, the engine room is generally located at the first stop level. There is an oil boiler and hydraulic machine (assembly), control panel and hoses through which the hydraulic fluid passes. Inside the elevator shaft the components are: cabin, counterweight (if any), cylinder-piston system, suspension device and buffers.

The pumped oil passes through the hydraulic machine, fulfilling certain conditions, and activates the cylinder through the pipes. The cylinder can be directly or indirectly connected to the cabinet. The cabin pushed by the cylinder is moved to the required floor with the received control.

SERVİS SİSTEMİ

SERVICE SYSTEM



Servis Asansörü

Servis asansörleri, 50 ila 300 kg arasındaki yükleri taşımak için tasarlanmış küçük yük asansörleridir. Servis asansörleri restoranlarda, kütüphanelerde, villalarda, hastanelerde ve ofislerde kullanılmaktadır. Restoranlarda genellikle yiyecek ve tabak taşımak için kullanıldığı için hijyen koşulları büyük önem taşımaktadır. Kabin içi paslanmaz çelik ve antibakteriyel malzemeden üretilmiştir.

Service Lift

Service elevators are small freight elevators designed to carry loads between 50 and 300 kg. Service elevators are used in restaurants, libraries, villas, hospitals and offices. Since it is generally used to carry food and plates in restaurants, hygienic conditions are of main importance. The cabin interior is made of stainless steel and antibacterial material.



VİLLA ASANSÖRÜ

HOME LIFT



Villa Asansör Sistemi

Ev asansörleri, inşaat sırasında veya mevcut binalara küçük tadilatlarla entegre edilmesi kolay, her şey dahil bir asansör kompleksidir. Tasarım, geniş renk ve malzeme seçeneklerimiz ile her proje mimari yapının statik ve tarzına uygun olarak gerçekleştirilmektedir. Proje bazlı çalıştığı için her türlü ebat ve kaplama seçenekleri değerlendirilmektedir.

Home Lift System

Home elevators are an all-inclusive elevator complex that is easy to integrate during construction or with minor renovations to existing buildings. With our design, wide color and material options, each project is carried out in accordance with the static and style of architectural structure. Since it works on a project basis, all kinds of size and coating options are evaluated.

HASTANE ASANSÖRÜ

HOSPITAL LIFT



Hastane Asansörü

Sedyeli asansörler olarak da bilinen hastane asansörleri, sedye üzerinde yatan hastaların taşınması için tasarlanmıştır. Sedyeli asansörler hastaların daha rahat ve güvenli taşınması için özel çalışma gerektirir. Sedyeli asansörlerin hızı çok yüksek değil, kabinler antibakteriyel olarak tasarlanmış, kabin aydınlatması hastaları rahatsız etmeyecek seviyede, kapıları daha geniş ve butonlara ulaşım daha kolay.

Hospital Lift

Home elevators are an all-inclusive elevator complex that is easy to integrate during construction or with minor renovations to existing buildings. With our design, wide color and material options, each project is carried out in accordance with the static and style of architectural structure. Since it works on a project basis, all kinds of size and coating options are evaluated.



GRANİT SEÇENEKLERİ

GRANITE OPTIONS

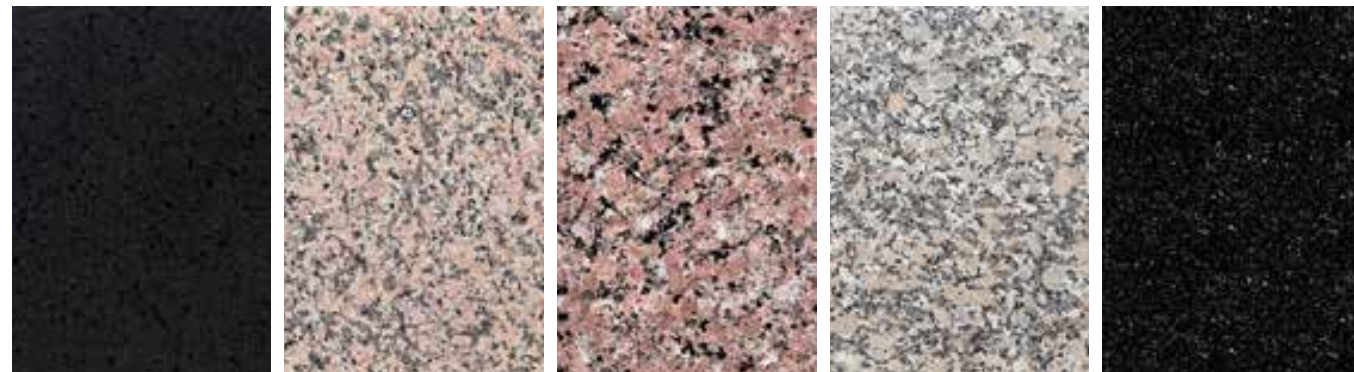

Black

Rosa Porino

Rosa Pink

Rosa Minho

Star Galaksi

PVC SEÇENEKLERİ

PVC OPTIONS



PVC-01

PVC-02

PVC-03

PVC-04

PVC-05

PVC-06

PVC-07

PVC-08

PVC-09

PVC-10

PVC-11

PVC-12

PVC-13

PVC-14

PVC-15

PVC-16

PVC-17

PVC-18

PVC-19

PVC-20

PASLANMAZ SEÇENEKLERİ

STAINLESS STEEL OPTIONS

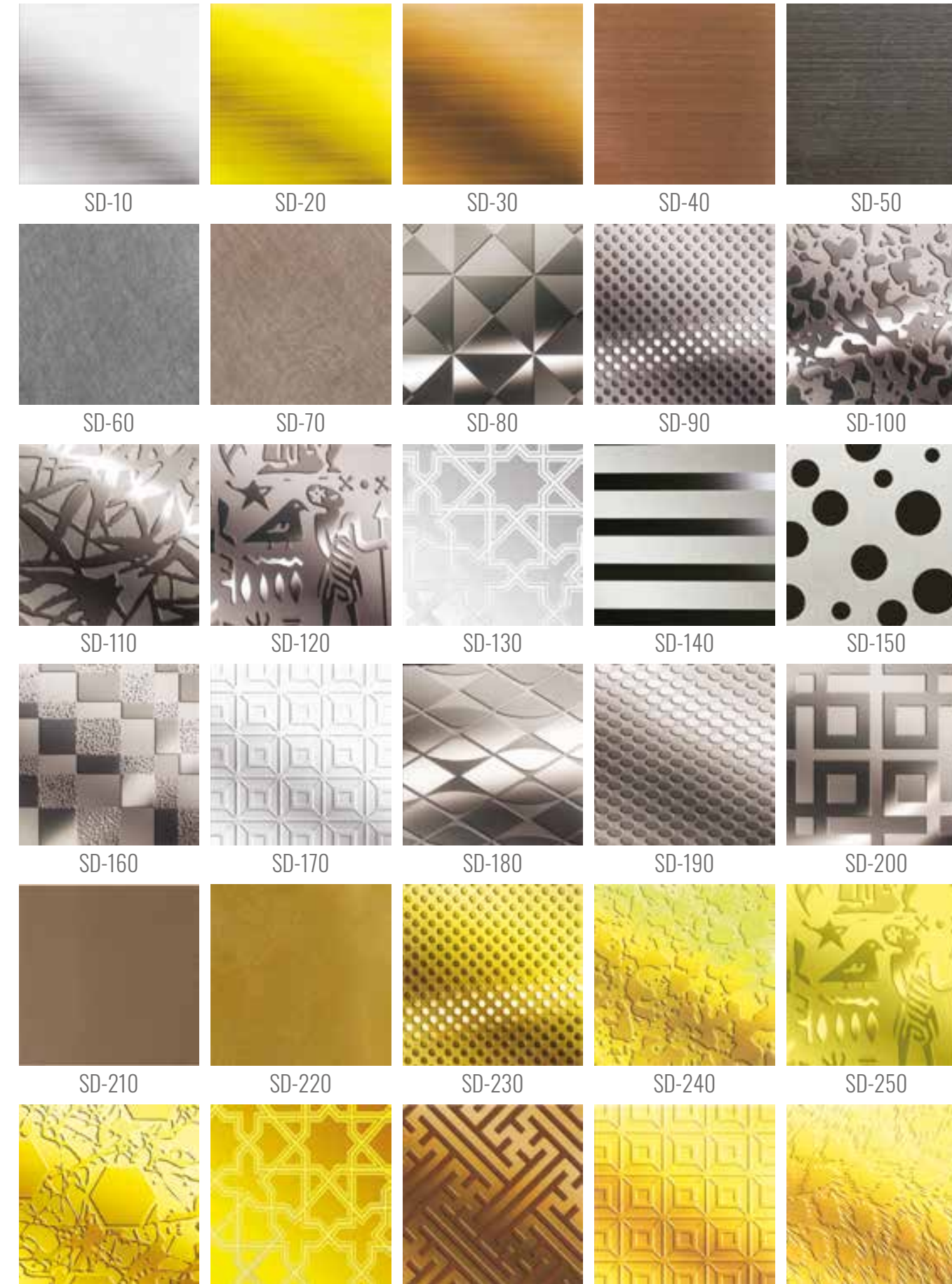

SD-10

SD-20

SD-30

SD-40

SD-50

SD-60

SD-70

SD-80

SD-90

SD-100

SD-110

SD-120

SD-130

SD-140

SD-150

SD-160

SD-170

SD-180

SD-190

SD-200

SD-210

SD-220

SD-230

SD-240

SD-250

SD-260

SD-270

SD-280

SD-290

SD-300



LAMİNANT SEÇENEKLERİ

LAMINATE OPTIONS



3023

3032

3051

3053

3077



3079

3085

3089

3094

3096

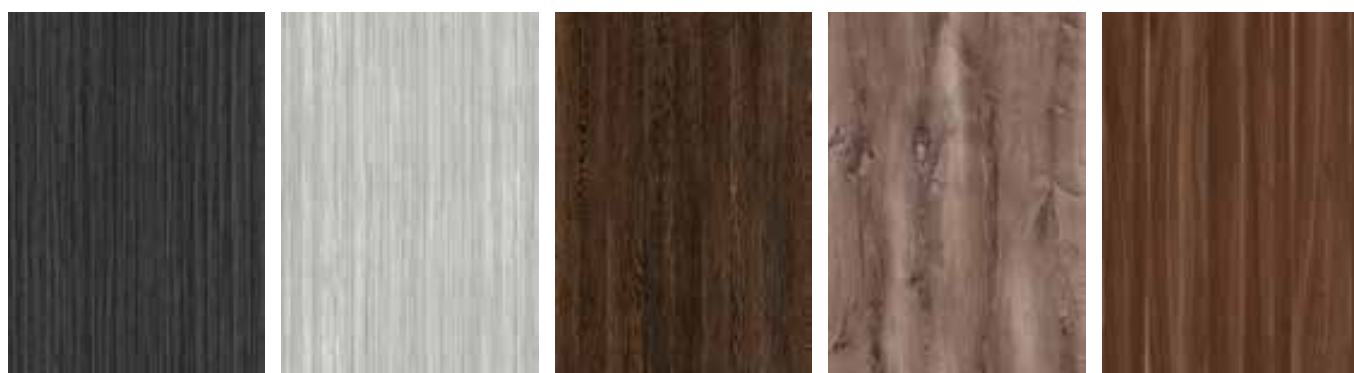

3121

3124

3136

3137

3142



3150

3167

3177

3180

3201

CAM SEÇENEKLERİ

GLASS OPTIONS

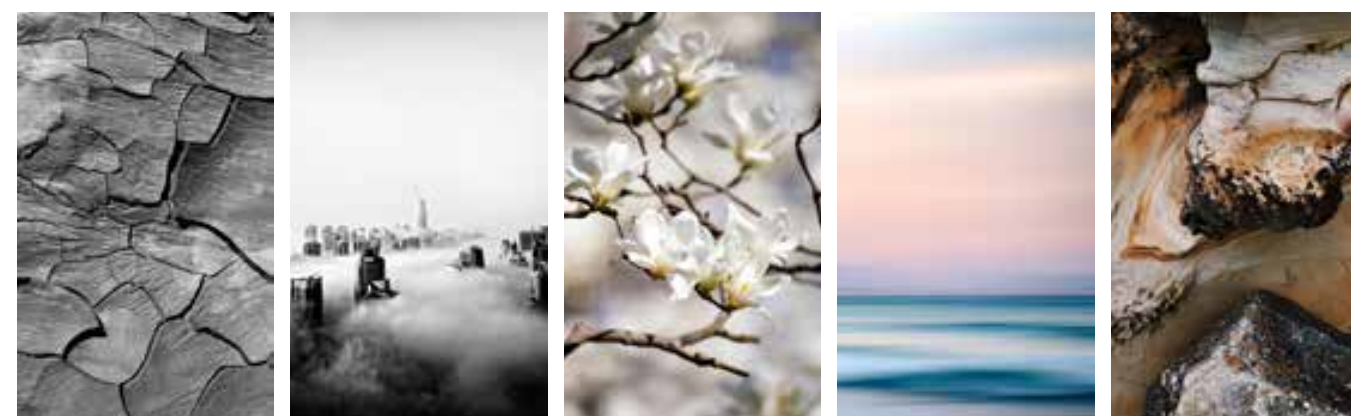

GL-01

GL-02

GL-03

GL-04

GL-05

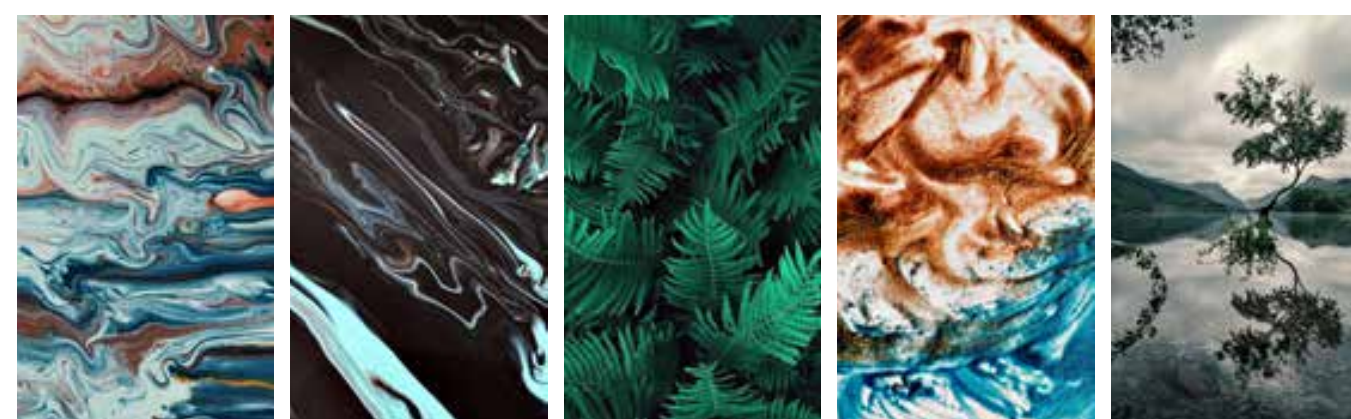

GL-06

GL-07

GL-08

GL-09

GL-10

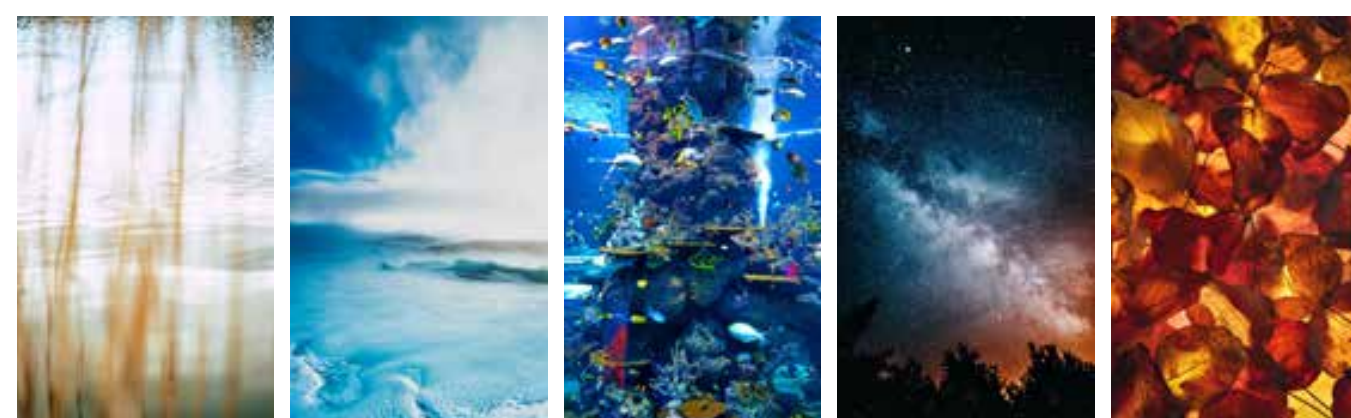

GL-11

GL-12

GL-13

GL-14

GL-15



GL-16

GL-17

GL-18

GL-19

GL-20

AVELIGE LAMINATE OPTIONS

AVELIGE STAINLESS STEEL OPTIONS





TAVAN SEÇENEKLERİ

CEILING OPTIONS



AVT 01

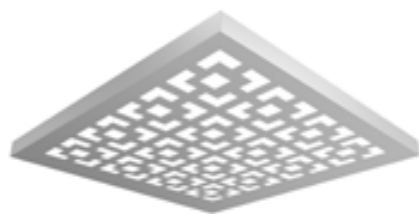

AVT 02



AVT 03



AVT 04



AVT 05

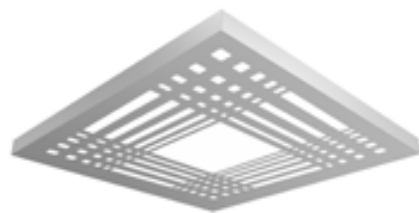

AVT 06



AVT 07

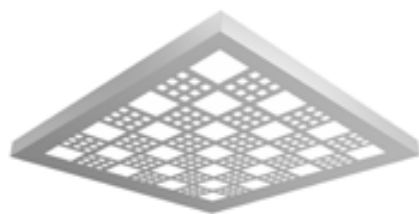

AVT 08



AVT 09



AVT 10

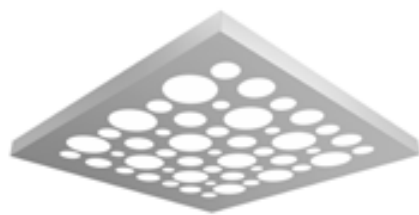

AVT 11



AVT 12

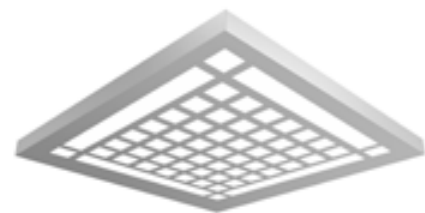

AVT 13



AVT 14



AVT 15



AVT 16



AVT 17



AVT 18

TAVAN SEÇENEKLERİ

CEILING OPTIONS



AVT 19



AVT 20



AVT 21



AVT 22



AVT 23



AVT 24



AVT 25



AVT 26



AVT 27



AVT 28



AVT 29



AVT 30



AVT 31

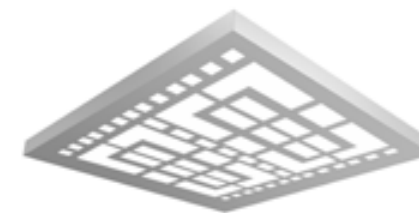

AVT 32



AVT 33

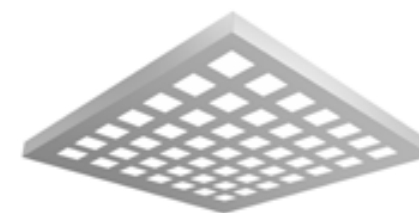

AVT 34

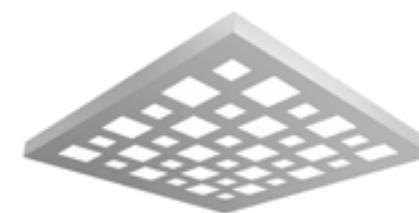

AVT 35



AVT 36



AVELICE CEILING OPTIONS



YEDEK PARÇA

SPARE PART



Ağırlık Çeşitleri

Manyetik Tüp

Aşırı Yük

Civata Somun Çeşitleri

Çelik Dübel



Denge Zinciri

Flexible Takoza

Ağırlık Ray Konsolu

Konsol

Ağırlık Alt Konsolu



Halat Şişesi

Boy Fotosel

Halat Tutucu

Döküm Kasnak

Plastik Kasnak



Denge Zinciri Makarası

Ray Tırnakları

Ray Bağlantı Flaşları

Ray

L Kabin Sabitleme Takoz

YEDEK PARÇA

SPARE PART

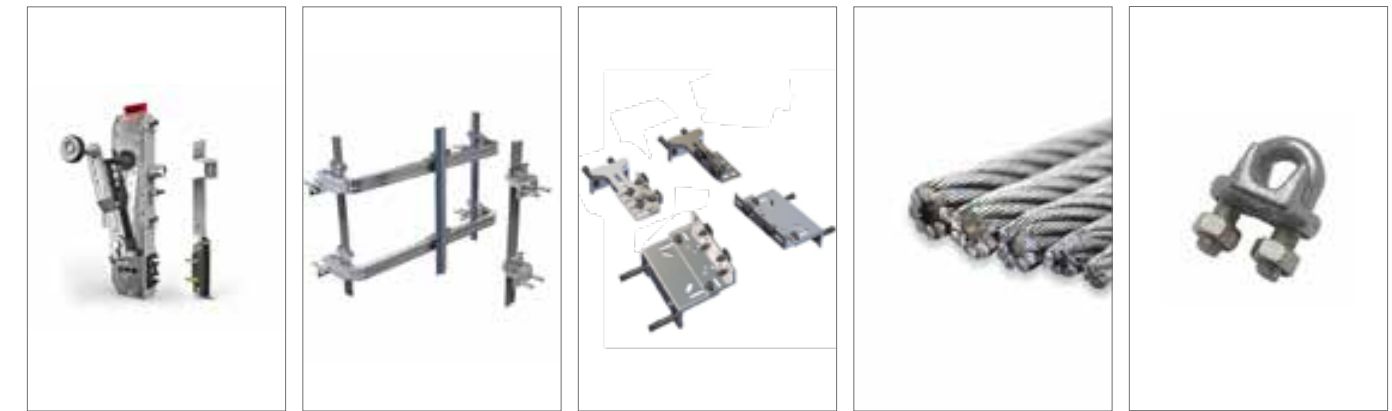

Kilit Çeşitleri

Yandan Konsol

Arkadan Konsol

Halat Çeşitleri

Halat Klemensleri



M10 Kabin Takoza

Makina Takoz Lastiği

Hidrolik Tampon

Poliüretan Tampon

Regulator

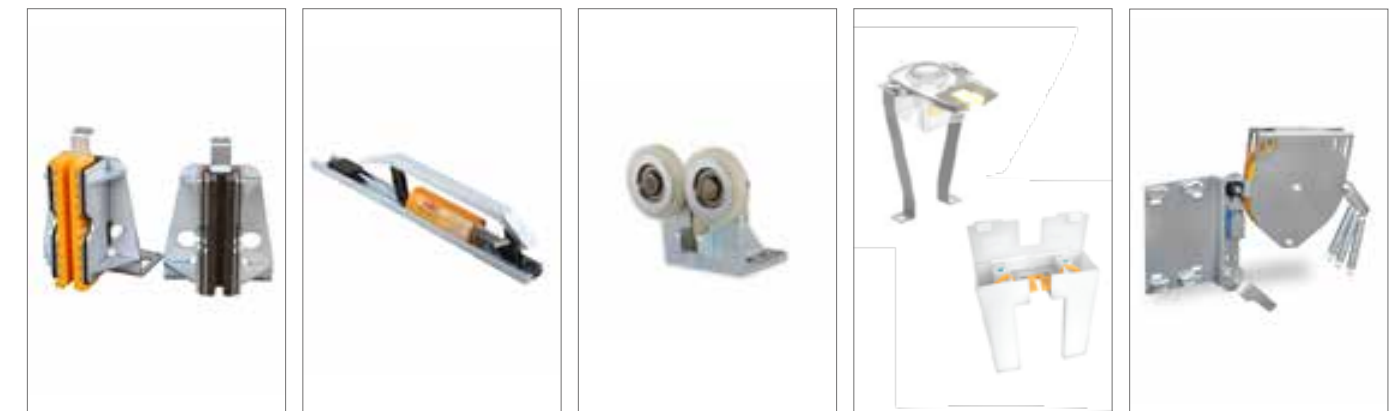

Sac Kabin Paten Bloğu

Lirpomp

Sac Kabin Paten Bloğu

Yağdanlık

Regulator Alt Yaylı



Yağ Toplama Kabı

Tırnak Çeşitleri

Paten Plastikleri

Kablo Çeşitleri

Fleksible Kablo



AVELIGE SPARE PART

ÖLÇÜ TABLOSU

SIZE OPTIONS

		KONUT ASANSÖRLERİ			GENEL AMAÇLI ASANSÖRLER (İŞYERİ VB.)					
		300kg (4 Kişilik)	450kg (6 Kişilik)	600kg (8 Kişilik)	600kg (8 Kişilik)	800kg (10 Kişilik)	1000kg (13 Kişilik)	1275kg (17 Kişilik)	1600kg (21 Kişilik)	
Kabin Ebatları (mm)	Genişlik (mm)	900	1000	1100	1100	1350	1100	2000	2100	
	Derinlik (mm)	1400	1200	1400	1400	1400	2100	1400	1600	
	Yükseklik (mm)	2200	2200	2200	2200	2200	2300	2300	2400	
Kabin Alanı	Maksimum (m ²)	0,9	1,3	1,6	1,6	2	2,35	2,95	3,56	
	Minimum (m ²)	0,79	1,17	1,45	1,45	1,73	2,15	2,71	3,24	
Kuyu Ebatları	Genişlik (mm)	1500	1600	1700	2000	2000	2200	2500	2700	
	Derinlik (mm)	1500	1700	1900	2100	2200	2200	2300	2500	
Kuyu Dibi Derinliği	0,63-1 m/s	1400	1400	1400	1400	1400	1400	1600	1600	
	1,6 m/s	1400	1600	1600	1600	1600	1600	1600	1600	
	2 m/s	1750	1750	1750	1750	1750	1750	1750	1750	
	2,5 m/s	2200	2200	2200	2200	2200	2200	2200	2200	
Kuyu Üstü Boşluğu	0,63-1 m/s	3700	3700	3700	3800	3800	4200	4200	•	
	1,6 m/s	3800	3800	3800	4000	4000	4200	4200	•	
	2 m/s	3800	3800	4300	4400	4400	4400	4400	•	
	2,5 m/s	5000	5000	5000	5000	5000	5200	5200	•	
Makine Dairesi Ebatları	Genişlik (mm)	2500	2500	2500	2500	3200	3200	3200	3200	
	Derinlik (mm)	3700	3700	3700	3700	4900	4900	4900	4900	
	Yükseklik (mm)	2000	2000	2000	2000	2000	2000	2000	2000	
	Hidrolik	Kuyunun Genişliği veya Derinliği * 2000 mm								

BELGELERİMİZ

OUR CERTIFICATES



AVELICE SIZE TABLE

AVELICE RALL CERTIFICATES